

---

**A WORLD OF ENCLOSURES**

# **EYEBOX EYEBOX SIMPLE**

## **SHORT FOLDER**

[www.italtronic.com](http://www.italtronic.com)











---













**italtronic**  
enclosures for electronics















## INDICE/INDEX







	P61610007A	Eye pannello rotondo trasparente Eye round transparent panel	PAG 11
	P61610009A	Eye pannello rotondo bianco Eye round panel white	PAG 11
	P61610008A	Eye pannello rotondo bianco 3 led Eye round panel white 3 leds	PAG 11
	P61610001T	Eye telaio superiore Eye top frame	PAG 12
	P61610002T	Eye telaio superiore - 5 digit Eye top frame - 5 digi	PAG 12
	P61610001V	Eye vaschetta pcb non equipaggiata Eye pcb enclosure not equipped	PAG 12
	P61610002V	Eye vaschetta pcb knx 4 pins per display vert e orizzont Eye enclosure pcb knx 4 pinsfor display vert and horiz	PAG 13
	P61610003V	Eye vasch. pcb per wago rj45,csf battery mors. per display vert.le Eye enclosure pcb for wago rj45,csfbattery, terminal for display vert.	PAG 13
	P61610004V	Eye vaschetta batteria 3xaaa per display orizzontale Eye enclosure battery 3xaaa fordisplay horizontal	PAG 13
	P61610001C	Eye intermedio non equipaggiato Eye intermediate not equipped	PAG 14
	P61610002C	Eye intermedio csf e mor a vite 5 pins p5,08 mm per disp vert e orizz. Eye intermediate csf and screwterminal 5pins p5,08 mm for displayvertical and horiz.	PAG 14

	P61610004C	Eye intermedio batteria 3xaaa per display verticale e orizzontale Eye intermediate battery 3xaaa for display vertical and horizontal	PAG 15
	P61610005C	Eye intermedio rj45 per display orizzontale e verticale Eye intermediate rj45 for display horizontal and vertical	PAG 15
	P61610006C	Eye intermedio wago 6pins p4mm per display verticale e orizzontale Eye intermediate wago 6pins p4mm for display vertical and horizontal	PAG 15
	P61610007C	Eye intermedio knx 4 pins per display orizzontale Eye intermediate knx 4 pins for display horizontal	PAG 16
	P61610001B	Eye base per fissaggio parete tipo csf Eye base for wall fixing type csf	PAG 16
	P61610002B	Eye base per fissaggio parete tipo std Eye base for wall fixing std type	PAG 15
	P61610002A	Eye elemento fissaggio csf su base a parete Eye fixing element csf on wall base	PAG 17
	P61610003G	Eye ghiera dentata Eye toothed ring	PAG 17
	P61610001A	Eye ruota dentata per encoder Eye toothed wheel for encoder	PAG 17
	P61610001G	Eye anello lucido bianco / Eye white shiny frame ring	PAG 18
	P61610002G	Eye anello zigrinato bianco Eye white knurled ring	PAG 18
	M612000042	Eye verniciatura lucida anello ral Eye shiny painting frame ring ral	PAG 18
	M612000043	Eye verniciatura opaca anello ral Eye opaque painting frame ring ral	PAG 19

	M612000044 Eye verniciatura soft touch anello ral Eye painting soft touch frame ring ral	PAG 19
	M612000046 Eye grafica rettangolare per tft 2,8" verticale e orizzontale Eye rectangular graphics for tft 2,8" vertical and horizontal	PAG 19
	M612000047 Eye grafica circolare per tft 2,8" Ø 43 mm bubble Eye circular graphics tft 2,8" Ø 43 mm bubble	PAG 20
	M612000048 Eye grafica circolare per tft 2,8" Ø 43 mm Eye circular graphics for tft 2,8" Ø 43 mm	PAG 20
	M612000049 Eye grafica per display led 5 digit Eye graphics for display led 5 digits	PAG 20
	M612000050 Eye grafica per 3 led Ø 5 mm Graphics for 3 led Ø 5 mm	PAG 21
	M612000051 Eye grafica per dimmer completa di rif per encoder e trimmer Eye graphics for dimmer complete of ref. for encoder and trimmer	PAG 21
	PM10012001 Vite 2,2x4,5 tc+. Screw 2,2x4,5 tc+	PAG 21
	PM10012003 Vite 2,2x6,5 tc+ Screw 2,2x6,5 tc+	PAG 22
	P61610003A Eye copriplacca standard Eye coverplate standard	PAG 22
	P61610004A Eye placca per fissaggio a parete o scatola elettrica Eye plate for wall fixing or electric enclosure	PAG 22

## EYE BOX

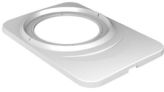
EYEBOX  
SIMPLE

	61.6100001	Eyebox simple kit con base standard Eyebox simple kit with standard base	PAG 24
	61.6100002	Eyebox simple kit con base per CSF Eyebox simple kit with CSF base	PAG 24
		Versioni speciali su richiesta - IMD decoration Special versions on demand - IMD decoration	PAG 24
		Lavorazioni CNC CNC lavorations	PAG 24
	PM10012003	Vite 2,2X6,5 TC+ Screw 2,2X6,5 TC+	PAG 25
	P61610003A	Eye copriplacca standard Eye coverplate standard	PAG 25
	M612000051	Eye placca per fissaggio a parete o scatola elettrica Eye plate for wall fixing or electric enclosure	PAG 25

STAMPA  
DIGITALE/  
DIGITAL PRINT

Finishing Service / Finishing Service

Pag. 26

## CARATTERISTICHE GENERALI

### Progettato per aderire alle tue esigenze

EYE BOX esprime la nuova frontiera di ITALTRONIC collegando il mondo industriale delle applicazioni per HOME & BUILDING AUTOMATION al valore del design dell'oggetto tecnologico, ampliandone la personalizzazione fino a renderlo esclusivo.

Il contenitore assume una forte caratterizzazione estetica, un aspetto finale accattivante ed è concepito per trasmettere un'emozione. Il nuovo concept permette al consumatore di interagire in modo funzionale e confortevole. Un mix consapevole di tecnologia e design.

Italtronic ha già realizzato EYE BOX basic mentre, le altre versioni, vengono presentate nel seguente catalogo come possibili idee di sviluppo. Partendo dal prodotto base, si potrà dare origine ad un'ampia gamma di soluzioni completamente personalizzabili.

Non solo molteplici colori e finiture ma una completa personalizzazione del frontale o della ghiera rotativa di regolazione, per ottenere molteplici prodotti con funzionalità diverse e uniche nel loro genere. Lo sviluppo consente molteplici connessioni a parete, sia elettriche che meccaniche, risolvendo la maggior parte delle necessità dei progettisti elettronici.

## GENERAL FEATURES

### Designed to satisfy your needs

EYE BOX is the new frontier for ITALTRONIC, joining the industrial world of HOME & BUILDING AUTOMATION applications with the design value of something technological, increasing the customization level to make it exclusive.

The enclosure has a highly impacting and attractive appearance, designed to transmit emotion. A new concept where the consumer is able to interact in a very functional and convenient way. An expert mix of technology and design.

Italtronic is already producing EYE BOX basic while the other versions are presented in this catalogue as potential development ideas. Starting with the basic product, you can create a vast range of totally customizable solutions.

Not just numerous colours and finishes, but total customization of the front panel or the regulation, generating numerous products with different and unique functions. Development enables various electrical and mechanical wall connections, which solve the majority of electronic designers' needs.

### EYE BOX DISPLAY

EYE BOX DISPLAY consente di personalizzare graficamente la lente ottenendo un effetto "iride" o qualsiasi vostra preferenza espressiva.

Le personalizzazioni grafiche infatti, possono essere studiate ad hoc dal committente per ottenere un display unico nel suo genere.

Il display alloggiato è di forma rettangolare, la forma tonda viene definita da una tampografia interna eseguita sulla lente.

### EYE BOX DISPLAY

EYE BOX DISPLAY gives graphic lens customisation, to create an "iris" effect or whatever effect you prefer.

In fact, the graphic customization can be studied exclusively for the customer to create a unique display.

The display itself is rectangular, while the round shape is given by internal pad printing on the lens.



## EYE BOX BELLEZZA A TUTTO TONDO

La linea di contenitori EYE BOX possiede una ghiera rotativa, cliccabile e personalizzabile in molteplici colori. La superficie inoltre, attraverso una modifica sullo stampo, può presentare una texture materica completamente personalizzabile.

Sono disponibili anche finiture speciali, come il rivestimento in legno, la cromatura e la finitura soft touch. Questo dettaglio conferirà al vostro contenitore uno stile unico.



## EYE BOX COLORI

Ogni contenitore può essere personalizzato con infinite colorazioni. Il colore può essere conferito al contenitore per mezzo di una verniciatura RAL o attraverso la scelta del colore master della materia prima, che verrà impiegata direttamente per la produzione.



## EYE BOX FINITURE

### Verniciatura RAL

Ogni contenitore può essere personalizzato con infinite colorazioni. Il colore può essere conferito al contenitore per mezzo di una verniciatura RAL o attraverso la scelta del colore master della materia prima, che verrà impiegata direttamente per la produzione.

### Stampa da master

È possibile realizzare il contenitore direttamente selezionando la matrice plastica colorata. Potrete così disporre di una personalizzazione sull'intera fornitura e rendere il vostro prodotto esclusivo e singolare.

## EYE BOX ALL ROUND BEAUTY

he line of EYE BOX enclosures has a rotary, clickable and customizable ring nut in numerous colours. By simply changing the mould, the surface can be finished with a totally customizable texture.

Special finishes are also available, such as wood coating, chrome plating and soft touch finish. This detail will give exclusive style to your enclosure.

## EYE BOX COLOURS

Each enclosure can be customised with an infinite range of colours. We can colour your enclosure using RAL paints or by choosing the master colour for the raw material that will be used directly in production.



## EYE BOX FINISHES

### RAL painting

Each enclosure can be customised with an infinite range of colours. We can colour your enclosure using RAL paints or by choosing the master colour for the raw material that will be used directly in production.

### Master mould

The enclosure can be made by choosing a coloured plastic matrix. This will enable customizing your entire supply and make your product unique.



## ACCESSORI PLACCA

La PLACCA EYE BOX in ABS con finitura estetica liscia e di colore bianco, completa la gamma ed è compatibile con qualsiasi fissaggio a parete. È un componente che si presta a molteplici personalizzazioni, dalla più semplice verniciatura in colore speciale, a finiture più complesse (cromatura / soft-touch) ed interventi sugli stampi ad iniezione plastica per ottenere una superficie materica.

Da impiegare con accessorio placca di fissaggio per scatole elettriche UK/USA/EUROPA, rispettivamente Ø 60, 3 posizioni e Ø 60 + 3 posizioni.

## EYE BOX DISPLAY

EYE BOX PLAQUE in abs with a smooth white finish, completes the range and is compatible with any wall fixing. This component can be customised numerous ways, from simple painting in a special colour through to more complex finishes (chrome plating / soft-touch) and plastic injection moulding for a textured surface.

Assembly with wall mounting element for electrical box use UK/USA/EUROPE respectively Ø 60, 3 gang and Ø 60 + 3 gang.



## EYE BOX Serie/Series

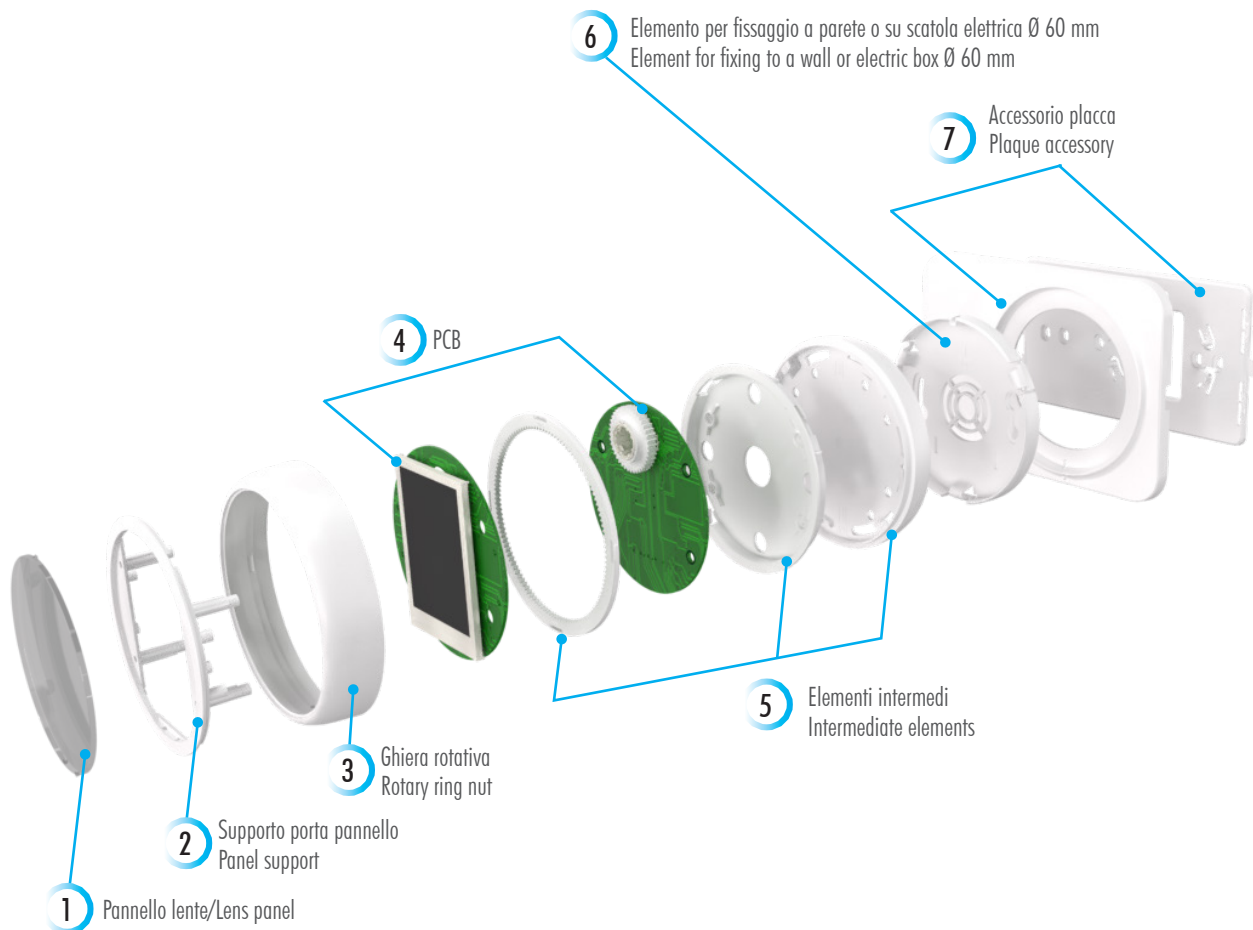

**Nota:** Il pannello lente, supporto porta anello e gli elementi intermedi sono dipendenti dalla configurazione prescelta.

**Note:** The lens panel, panel support and the intermediate elements depend on the chosen configuration.

# ENCLOSURE SYSTEM EYE BOX

## ASSEMBLAGGIO/DISASSEMBLAGGIO

## ASSEMBLY/DISASSEMBLY

MONTAGGIO/ASSEMBLY

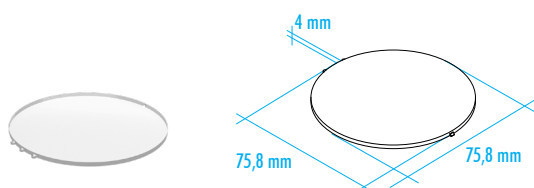

SMONTAGGIO/DISASSEMBLY

**PANNELLO FRONTALE****CARATTERISTICHE GENERALI****Materiale:** PC autoestinguente UL94-V2**Colore:** Trasparente**FRONT PANEL****GENERAL FEATURES****Material:** PC self-extinguishing UL94-V2**Colour:** Transparent

CODICE / CODE	COLORE / COLOUR	DESCRIZIONE/DESCRIPTION
P61610007A	Trasparente/Transparent	Eye pannello rotondo trasparente/Eye round transparent panel

<b>CONFEZIONE N° PCS/KIT:</b>	<b>25</b>
<b>PACKAGING N° PCS/KIT:</b>	<b>25</b>
<b>PESO DELLA CONFEZIONE:</b>	<b>0,50 kg</b>
<b>PACKAGING WEIGHT:</b>	<b>0,50 kg</b>

<b>MINIMO ACQUISTABILE:</b>	<b>1</b>
<b>MINIMUM ORDER:</b>	<b>1</b>
<b>PESO DEL PEZZO KIT:</b>	<b>16 g</b>
<b>KIT WEIGHT:</b>	<b>16 g</b>

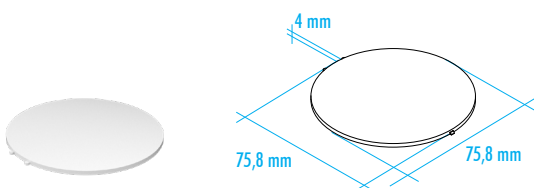
**PANNELLO FRONTALE****CARATTERISTICHE GENERALI****Materiale:** ABS autoestinguente UL94-V0**Colore:** Bianco**FRONT PANEL****GENERAL FEATURES****Material:** ABS self-extinguishing UL94-V0**Colour:** White

CODICE / CODE	COLORE / COLOUR	DESCRIZIONE/DESCRIPTION
P61610009A	Bianco/White	Eye pannello rotondo bianco / Eye round panel white

<b>CONFEZIONE N° PCS/KIT:</b>	<b>25</b>
<b>PACKAGING N° PCS/KIT:</b>	<b>25</b>
<b>PESO DELLA CONFEZIONE:</b>	<b>0,50 kg</b>
<b>PACKAGING WEIGHT:</b>	<b>0,50 kg</b>

<b>MINIMO ACQUISTABILE:</b>	<b>1</b>
<b>MINIMUM ORDER:</b>	<b>1</b>
<b>PESO DEL PEZZO KIT:</b>	<b>16 g</b>
<b>KIT WEIGHT:</b>	<b>16 g</b>

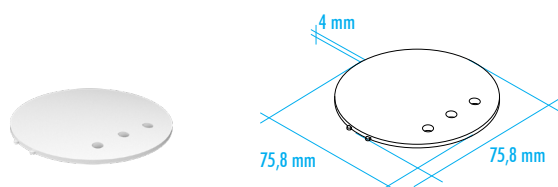
**PANNELLO FRONTALE****CARATTERISTICHE GENERALI****Materiale:** ABS autoestinguente UL94-V0**Colore:** Bianco**FRONT PANEL****GENERAL FEATURES****Material:** ABS self-extinguishing UL94-V0**Colour:** White

CODICE / CODE	COLORE / COLOUR	DESCRIZIONE/DESCRIPTION
P61610008A	Bianco/White	Eye pannello rotondo bianco 3 led / Eye round panel white 3 leds

<b>CONFEZIONE N° PCS/KIT:</b>	<b>25</b>
<b>PACKAGING N° PCS/KIT:</b>	<b>25</b>
<b>PESO DELLA CONFEZIONE:</b>	<b>0,50 kg</b>
<b>PACKAGING WEIGHT:</b>	<b>0,50 kg</b>

<b>MINIMO ACQUISTABILE:</b>	<b>1</b>
<b>MINIMUM ORDER:</b>	<b>1</b>
<b>PESO DEL PEZZO KIT:</b>	<b>16 g</b>
<b>KIT WEIGHT:</b>	<b>16 g</b>

## TELAIO

## CARATTERISTICHE GENERALI

Material: ABS autoestinguente UL94-V0

Colore: Bianco

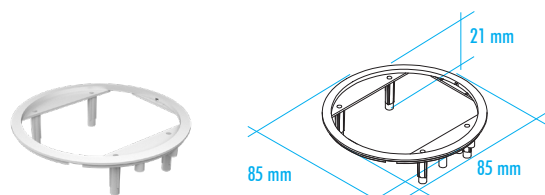

## FRAME

## GENERAL FEATURES

Material: ABS self-extinguishing UL94-V0

Colour: White



CODICE / CODE	COLORE / COLOUR	DESCRIZIONE/DESCRIPTION
P61610001T	Bianco/White	Eye telaio superiore / Eye top frame

CONFEZIONE N° PCS/KIT:	25
PACKAGING N° PCS/KIT:	25
PESO DELLA CONFEZIONE:	0,20 kg
PACKAGING WEIGHT:	0,20 kg

MINIMO ACQUISTABILE:	1
MINIMUM ORDER:	1
PESO DEL PEZZO KIT:	6 g
KIT WEIGHT:	6 g

## TELAIO

## CARATTERISTICHE GENERALI

Material: ABS autoestinguente UL94-V0

Colore: Bianco

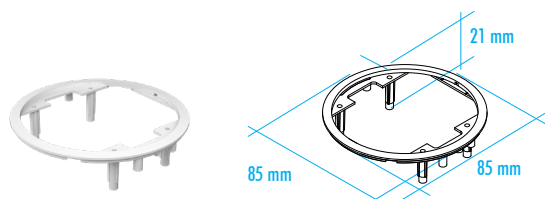

## FRAME

## GENERAL FEATURES

Material: ABS self-extinguishing UL94-V0

Colour: White



CODICE / CODE	COLORE / COLOUR	DESCRIZIONE/DESCRIPTION
P61610002T	Bianco/White	Eye telaio superiore - 5 digit / Eye top frame - 5 digit

CONFEZIONE N° PCS/KIT:	25
PACKAGING N° PCS/KIT:	25
PESO DELLA CONFEZIONE:	0,20 kg
PACKAGING WEIGHT:	0,20 kg

MINIMO ACQUISTABILE:	1
MINIMUM ORDER:	1
PESO DEL PEZZO KIT:	6 g
KIT WEIGHT:	6 g

## VASCHETTA INTERNA

## CARATTERISTICHE GENERALI

Material: ABS autoestinguente UL94-V0

Colore: Bianco

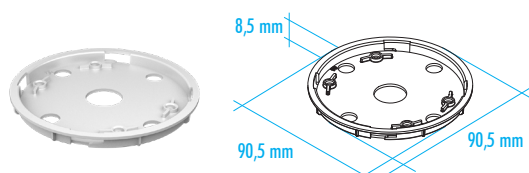

## INNER PAN

## GENERAL FEATURES

Material: ABS self-extinguishing UL94-V0

Colour: White



CODICE / CODE	COLORE / COLOUR	DESCRIZIONE/DESCRIPTION
P61610001V	Bianco/White	Eye vaschetta PCB non equipaggiata / Eye PCB enclosure not equipped

CONFEZIONE N° PCS/KIT:	25
PACKAGING N° PCS/KIT:	25
PESO DELLA CONFEZIONE:	0,48 kg
PACKAGING WEIGHT:	0,48 kg

MINIMO ACQUISTABILE:	1
MINIMUM ORDER:	1
PESO DEL PEZZO KIT:	12 g
KIT WEIGHT:	12 g

**VASCHETTA INTERNA****CARATTERISTICHE GENERALI**

**Materiale:** ABS autoestinguente UL94-V0

**Colore:** Bianco

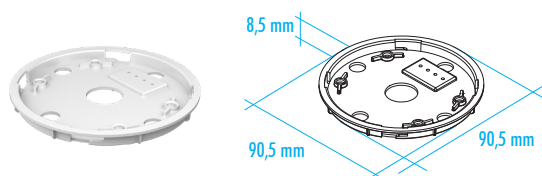
**INNER PAN****GENERAL FEATURES**

**Material:** ABS self-extinguishing UL94-V0

**Colour:** White



CODICE / CODE	COLORE / COLOUR	DESCRIZIONE/DESCRIPTION
P61610002V	Bianco/White	Eye vaschetta PCB KNX 4 pins per display vert e orizzont / Eye enclosure PCB KNX 4 pinsfor display vert and horiz

<b>CONFEZIONE N° PCS/KIT:</b>	<b>25</b>
<b>PACKAGING N° PCS/KIT:</b>	<b>25</b>
<b>PESO DELLA CONFEZIONE:</b>	<b>0,48 kg</b>
<b>PACKAGING WEIGHT:</b>	<b>0,48 kg</b>

<b>MINIMO ACQUISTABILE:</b>	<b>1</b>
<b>MINIMUM ORDER:</b>	<b>1</b>
<b>PESO DEL PEZZO KIT:</b>	<b>14 g</b>
<b>KIT WEIGHT:</b>	<b>14 g</b>

**VASCHETTA INTERNA****CARATTERISTICHE GENERALI**

**Materiale:** ABS autoestinguente UL94-V0

**Colore:** Bianco

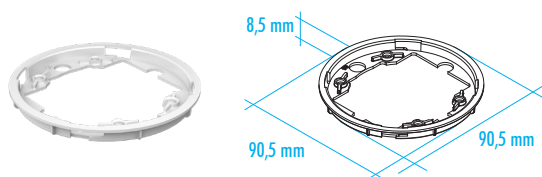
**INNER PAN****GENERAL FEATURES**

**Material:** ABS self-extinguishing UL94-V0

**Colour:** White



CODICE / CODE	COLORE / COLOUR	DESCRIZIONE/DESCRIPTION
P61610003V	Bianco/White	Eye vasch. pcb per wago rj45,csf battery mors. per display vert.le Eye enclosure pcb for wago rj45,csfbattery, terminal for display vert.

<b>CONFEZIONE N° PCS/KIT:</b>	<b>25</b>
<b>PACKAGING N° PCS/KIT:</b>	<b>25</b>
<b>PESO DELLA CONFEZIONE:</b>	<b>0,40 kg</b>
<b>PACKAGING WEIGHT:</b>	<b>0,40 kg</b>

<b>MINIMO ACQUISTABILE:</b>	<b>1</b>
<b>MINIMUM ORDER:</b>	<b>1</b>
<b>PESO DEL PEZZO KIT:</b>	<b>8 g</b>
<b>KIT WEIGHT:</b>	<b>8 g</b>

**VASCHETTA INTERNA****CARATTERISTICHE GENERALI**

**Materiale:** ABS autoestinguente UL94-V0

**Colore:** Bianco

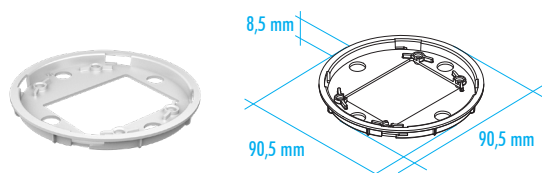
**INNER PAN****GENERAL FEATURES**

**Material:** ABS self-extinguishing UL94-V0

**Colour:** White



CODICE / CODE	COLORE / COLOUR	DESCRIZIONE/DESCRIPTION
P61610004V	Bianco/White	Eye vaschetta batteria 3xAAA per display orizzontale / Eye enclosure battery 3xAAA fordisplay horizontal

<b>CONFEZIONE N° PCS/KIT:</b>	<b>25</b>
<b>PACKAGING N° PCS/KIT:</b>	<b>25</b>
<b>PESO DELLA CONFEZIONE:</b>	<b>0,45 kg</b>
<b>PACKAGING WEIGHT:</b>	<b>0,45 kg</b>

<b>MINIMO ACQUISTABILE:</b>	<b>1</b>
<b>MINIMUM ORDER:</b>	<b>1</b>
<b>PESO DEL PEZZO KIT:</b>	<b>10 g</b>
<b>KIT WEIGHT:</b>	<b>10 g</b>

**CORPO CON MOLLE****CARATTERISTICHE GENERALI**

**Materiale:** ABS autoestinguente UL94-V0

**Colore:** Bianco

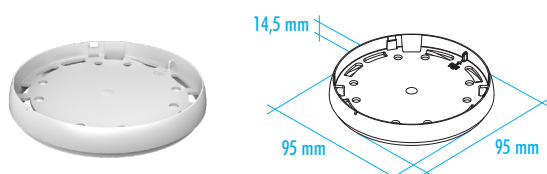
**BODY WITH SPRINGS****GENERAL FEATURES**

**Material:** ABS self-extinguishing UL94-V0

**Colour:** White



CODICE / CODE	COLORE / COLOUR	DESCRIZIONE/DESCRIPTION
P61610001C	Bianco/White	Eye intermedio non equipaggiato/Eye intermediate not equipped

<b>CONFEZIONE N° PCS/KIT:</b>	<b>25</b>
<b>PACKAGING N° PCS/KIT:</b>	<b>25</b>
<b>PESO DELLA CONFEZIONE:</b>	<b>0,60 kg</b>
<b>PACKAGING WEIGHT:</b>	<b>0,60 kg</b>

<b>MINIMO ACQUISTABILE:</b>	<b>1</b>
<b>MINIMUM ORDER:</b>	<b>1</b>
<b>PESO DEL PEZZO KIT:</b>	<b>18 g</b>
<b>KIT WEIGHT:</b>	<b>18 g</b>

**CORPO CON MOLLE****CARATTERISTICHE GENERALI**

**Materiale:** ABS autoestinguente UL94-V0

**Colore:** Bianco

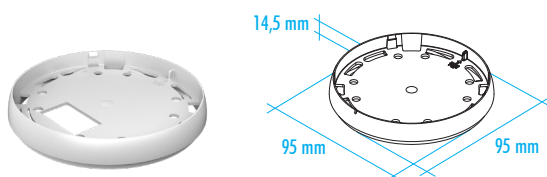
**BODY WITH SPRINGS****GENERAL FEATURES**

**Material:** ABS self-extinguishing UL94-V0

**Colour:** White



CODICE / CODE	COLORE / COLOUR	DESCRIZIONE/DESCRIPTION
P61610002C	Bianco/White	Eye intermedio CSF e mor a vite 5 pins p5,08 mm per disp vert e orizz Eye intermediate CSF and screwterminal 5pins p5,08 mm for displayvertical and horiz.

<b>CONFEZIONE N° PCS/KIT:</b>	<b>25</b>
<b>PACKAGING N° PCS/KIT:</b>	<b>25</b>
<b>PESO DELLA CONFEZIONE:</b>	<b>0,60 kg</b>
<b>PACKAGING WEIGHT:</b>	<b>0,60 kg</b>

<b>MINIMO ACQUISTABILE:</b>	<b>1</b>
<b>MINIMUM ORDER:</b>	<b>1</b>
<b>PESO DEL PEZZO KIT:</b>	<b>18 g</b>
<b>KIT WEIGHT:</b>	<b>18 g</b>

**CORPO CON MOLLE****CARATTERISTICHE GENERALI**

**Materiale:** ABS autoestinguente UL94-V0

**Colore:** Bianco

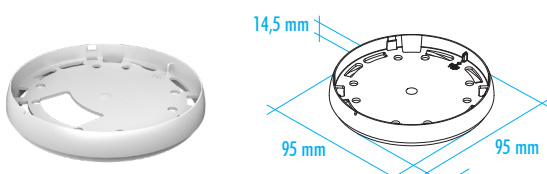
**BODY WITH SPRINGS****GENERAL FEATURES**

**Material:** ABS self-extinguishing UL94-V0

**Colour:** White



CODICE / CODE	COLORE / COLOUR	DESCRIZIONE/DESCRIPTION
P61610003C	Bianco/White	Eye intermedio KNX 4 pins p4 mm per display verticale / Eye intermediate KNX 4 pins p4 mm for display vertical

<b>CONFEZIONE N° PCS/KIT:</b>	<b>25</b>
<b>PACKAGING N° PCS/KIT:</b>	<b>25</b>
<b>PESO DELLA CONFEZIONE:</b>	<b>0,60 kg</b>
<b>PACKAGING WEIGHT:</b>	<b>0,60 kg</b>

<b>MINIMO ACQUISTABILE:</b>	<b>1</b>
<b>MINIMUM ORDER:</b>	<b>1</b>
<b>PESO DEL PEZZO KIT:</b>	<b>18 g</b>
<b>KIT WEIGHT:</b>	<b>18 g</b>



**CORPO CON MOLLE****CARATTERISTICHE GENERALI**

Materiale: ABS autoestinguente UL94-V0

Colore: Bianco

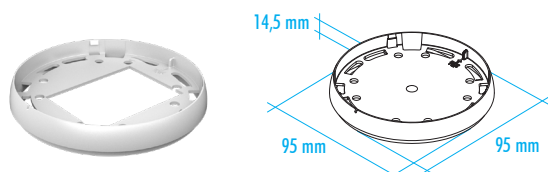
**BODY WITH SPRINGS****GENERAL FEATURES**

Material: ABS self-extinguishing UL94-V0

Colour: White



CODICE / CODE	COLORE / COLOUR	DESCRIZIONE/DESCRIPTION
P61610004C	Bianco/White	Eye intermedio batteria 3xaaa per display verticale e orizzontale Eye intermediate battery 3xaaa for display vertical and horizontal

**CONFEZIONE N° PCS/KIT:** 25  
**PACKAGING N° PCS/KIT:** 25

**MINIMO ACQUISTABILE:** 1  
**MINIMUM ORDER:** 1

**PESO DELLA CONFEZIONE:** 0,60 kg  
**PACKAGING WEIGHT:** 0,60 kg

**PESO DEL PEZZO KIT:** 18 g  
**KIT WEIGHT:** 18 g

**CORPO CON MOLLE****CARATTERISTICHE GENERALI**

Materiale: ABS autoestinguente UL94-V0

Colore: Bianco

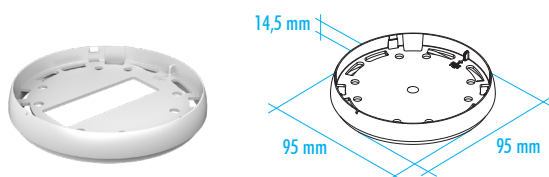
**BODY WITH SPRINGS****GENERAL FEATURES**

Material: ABS self-extinguishing UL94-V0

Colour: White



CODICE / CODE	COLORE / COLOUR	DESCRIZIONE/DESCRIPTION
P61610005C	Bianco/White	Eye intermedio RJ45 per display orizzontale e verticale Eye intermediate RJ45 for display horizontal and vertical

**CONFEZIONE N° PCS/KIT:** 25  
**PACKAGING N° PCS/KIT:** 25

**MINIMO ACQUISTABILE:** 1  
**MINIMUM ORDER:** 1

**PESO DELLA CONFEZIONE:** 0,60 kg  
**PACKAGING WEIGHT:** 0,60 kg

**PESO DEL PEZZO KIT:** 18 g  
**KIT WEIGHT:** 18 g

**CORPO CON MOLLE****CARATTERISTICHE GENERALI**

Materiale: ABS autoestinguente UL94-V0

Colore: Bianco

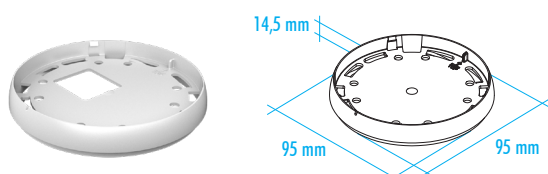
**BODY WITH SPRINGS****GENERAL FEATURES**

Material: ABS self-extinguishing UL94-V0

Colour: White



CODICE / CODE	COLORE / COLOUR	DESCRIZIONE/DESCRIPTION
P61610006C	Bianco/White	Eye intermedio WAGO 6pins p4mm per display verticale e orizzontale Eye intermediate WAGO 6pins p4mmfor display vertical and horizontal

**CONFEZIONE N° PCS/KIT:** 25  
**PACKAGING N° PCS/KIT:** 25

**MINIMO ACQUISTABILE:** 1  
**MINIMUM ORDER:** 1

**PESO DELLA CONFEZIONE:** 0,60 kg  
**PACKAGING WEIGHT:** 0,60 kg

**PESO DEL PEZZO KIT:** 18 g  
**KIT WEIGHT:** 18 g

**CORPO CON MOLLE****CARATTERISTICHE GENERALI**

**Materiale:** ABS autoestinguente UL94-V0

**Colore:** Bianco

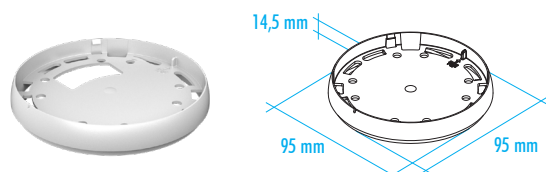
**BODY WITH SPRINGS****GENERAL FEATURES**

**Material:** ABS self-extinguishing UL94-V0

**Colour:** White



CODICE / CODE	COLORE / COLOUR	DESCRIZIONE/DESCRIPTION
P61610007C	Bianco/White	Eye intermedio KNX 4 pins per display orizzontale / Eye intermediate KNX 4 pins for display horizontal

**CONFEZIONE N° PCS/KIT:** 25  
**PACKAGING N° PCS/KIT:** 25

**MINIMO ACQUISTABILE: 1**  
**MINIMUM ORDER:** 1

**PESO DELLA CONFEZIONE:** 0,60 kg  
**PACKAGING WEIGHT:** 0,60 kg

**PESO DEL PEZZO KIT:** 18 g  
**KIT WEIGHT:** 18 g

**BASE****CARATTERISTICHE GENERALI**

**Materiale:** ABS autoestinguente UL94-V0

**Colore:** Bianco

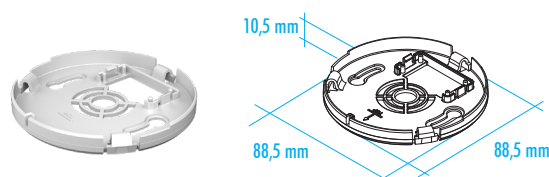
**BASE****GENERAL FEATURES**

**Material:** ABS self-extinguishing UL94-V0

**Colour:** White



CODICE / CODE	COLORE / COLOUR	DESCRIZIONE/DESCRIPTION
P61610001B	Bianco/White	Eye base per fissaggio parete tipo CSF / Eye base for wall fixing type CSF

**CONFEZIONE N° PCS/KIT:** 25  
**PACKAGING N° PCS/KIT:** 25

**MINIMO ACQUISTABILE: 1**  
**MINIMUM ORDER:** 1

**PESO DELLA CONFEZIONE:** 0,42 kg  
**PACKAGING WEIGHT:** 0,42 kg

**PESO DEL PEZZO KIT:** 14 g  
**KIT WEIGHT:** 14 g

**BASE****CARATTERISTICHE GENERALI**

**Materiale:** ABS autoestinguente UL94-V0

**Colore:** Bianco

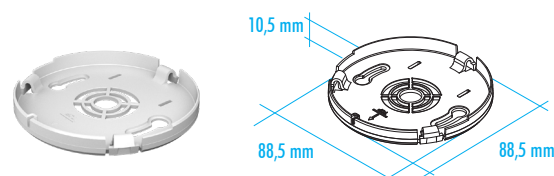
**BASE****GENERAL FEATURES**

**Material:** ABS self-extinguishing UL94-V0

**Colour:** White



CODICE / CODE	COLORE / COLOUR	DESCRIZIONE/DESCRIPTION
P61610002B	Bianco/White	Eye base per fissaggio parete tipo STD / Eye base for wall fixing type STD

**CONFEZIONE N° PCS/KIT:** 25  
**PACKAGING N° PCS/KIT:** 25

**MINIMO ACQUISTABILE: 1**  
**MINIMUM ORDER:** 1

**PESO DELLA CONFEZIONE:** 0,42 kg  
**PACKAGING WEIGHT:** 0,42 kg

**PESO DEL PEZZO KIT:** 14 g  
**KIT WEIGHT:** 14 g



## BASE

## CARATTERISTICHE GENERALI

Material: ABS autoestinguente UL94-V0

Colore: Bianco

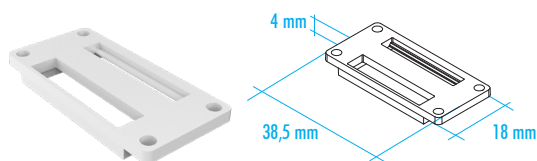

## BASE

## GENERAL FEATURES

Material: ABS self-extinguishing UL94-V0

Colour: White



CODICE / CODE	COLORE / COLOUR	DESCRIZIONE/DESCRIPTION
P61610002A	Bianco/White	Eye elemento fissaggio CSF su base a parete / Eye fixing element CSF on wall base

CONFEZIONE N° PCS/KIT: 25  
PACKAGING N° PCS/KIT: 25

MINIMO ACQUISTABILE: 1  
MINIMUM ORDER: 1

PESO DELLA CONFEZIONE: 0,07 kg  
PACKAGING WEIGHT: 0,07 kg

PESO DEL PEZZO KIT: 1 g  
KIT WEIGHT: 1 g

BASE/BASE

## GHIERA DENTATA

## CARATTERISTICHE GENERALI

Material: ABS autoestinguente UL94-V0

Colore: Bianco

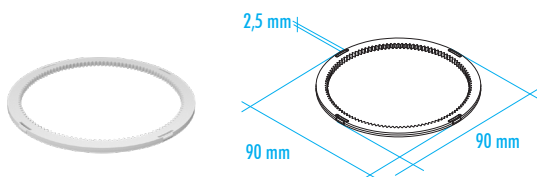

## TOOTHED RING

## GENERAL FEATURES

Material: ABS self-extinguishing UL94-V0

Colour: White



CODICE / CODE	COLORE / COLOUR	DESCRIZIONE/DESCRIPTION
P61610003G	Bianco/White	Eye ghiera dentata / Eye toothed ring

CONFEZIONE N° PCS/KIT: 25  
PACKAGING N° PCS/KIT: 25

MINIMO ACQUISTABILE: 1  
MINIMUM ORDER: 1

PESO DELLA CONFEZIONE: 0,15 kg  
PACKAGING WEIGHT: 0,15 kg

PESO DEL PEZZO KIT: 4 g  
KIT WEIGHT: 4 g

## RUOTA DENTATA

## CARATTERISTICHE GENERALI

Material: ABS autoestinguente UL94-V0

Colore: Bianco

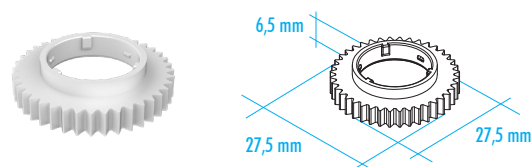

## TOOTHED WHEEL

## GENERAL FEATURES

Material: ABS self-extinguishing UL94-V0

Colour: White



CODICE / CODE	COLORE / COLOUR	DESCRIZIONE/DESCRIPTION
P61610001A	Bianco/White	Eye ruota dentata per encoder / Eye toothed wheel for encoder

CONFEZIONE N° PCS/KIT: 25  
PACKAGING N° PCS/KIT: 25

MINIMO ACQUISTABILE: 1  
MINIMUM ORDER: 1

PESO DELLA CONFEZIONE: 0,07 kg  
PACKAGING WEIGHT: 0,07 kg

PESO DEL PEZZO KIT: 1 g  
KIT WEIGHT: 1 g

ANELLO/RING

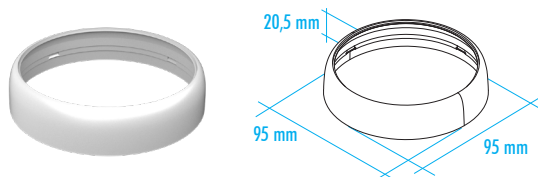
**ANELLO****CARATTERISTICHE GENERALI****Materiale:** ABS autoestinguente UL94-V0**Colore:** Bianco**RING****GENERAL FEATURES****Material:** ABS self-extinguishing UL94-V0**Colour:** White

CODICE / CODE	COLORE / COLOUR	DESCRIZIONE/DESCRIPTION
P61610001G	Bianco/White	Eye anello lucido bianco / Eye white shiny frame ring

<b>CONFEZIONE N° PCS/KIT:</b>	<b>25</b>
<b>PACKAGING N° PCS/KIT:</b>	<b>25</b>
<b>PESO DELLA CONFEZIONE:</b>	<b>0,55 kg</b>
<b>PACKAGING WEIGHT:</b>	<b>0,55 kg</b>

<b>MINIMO ACQUISTABILE: 1</b>	<b>MINIMUM ORDER: 1</b>
<b>PESO DEL PEZZO KIT: 14 g</b>	<b>KIT WEIGHT: 14 g</b>

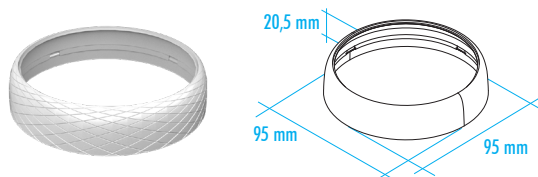
**ANELLO****CARATTERISTICHE GENERALI****Materiale:** ABS autoestinguente UL94-V0**Colore:** Bianco**RING****GENERAL FEATURES****Material:** ABS self-extinguishing UL94-V0**Colour:** White

CODICE / CODE	COLORE / COLOUR	DESCRIZIONE/DESCRIPTION
P61610002G	Bianco/White	Eye anello zigrinato bianco / Eye white knurled ring

<b>CONFEZIONE N° PCS/KIT:</b>	<b>25</b>
<b>PACKAGING N° PCS/KIT:</b>	<b>25</b>
<b>PESO DELLA CONFEZIONE:</b>	<b>0,55 kg</b>
<b>PACKAGING WEIGHT:</b>	<b>0,55 kg</b>

<b>MINIMO ACQUISTABILE: 1</b>	<b>MINIMUM ORDER: 1</b>
<b>PESO DEL PEZZO KIT: 14 g</b>	<b>KIT WEIGHT: 14 g</b>

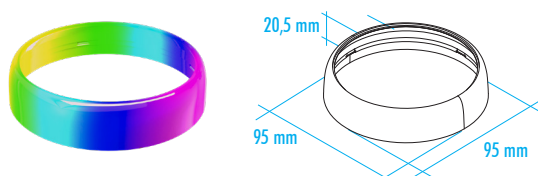
**ANELLO****CARATTERISTICHE GENERALI****Materiale:** ABS autoestinguente UL94-V0**Colore:** Verniciato a specifica RAL LUCIDO**RING****GENERAL FEATURES****Material:** ABS self-extinguishing UL94-V0**Colour:** Painted in according request RAL SHINY

CODICE / CODE	COLORE / COLOUR	DESCRIZIONE/DESCRIPTION
M612000042	RAL	Eye verniciatura lucida anello RAL / Eye shiny painting frame ring RAL

<b>CONFEZIONE N° PCS/KIT:</b>	<b>25</b>
<b>PACKAGING N° PCS/KIT:</b>	<b>25</b>
<b>PESO DELLA CONFEZIONE:</b>	<b>0,55 kg</b>
<b>PACKAGING WEIGHT:</b>	<b>0,55 kg</b>

<b>MINIMO ACQUISTABILE: 1</b>	<b>MINIMUM ORDER: 1</b>
<b>PESO DEL PEZZO KIT: 14 g</b>	<b>KIT WEIGHT: 14 g</b>

## ANELLO

## CARATTERISTICHE GENERALI

**Materiale:** ABS autoestinguente UL94-V0

**Colore:** Verniciato a specifica RAL OPACO

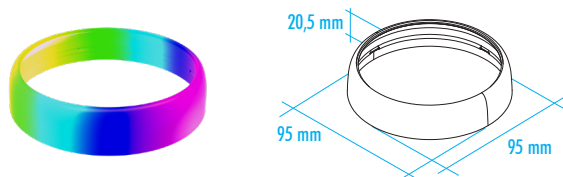

CODICE / CODE	COLORE / COLOUR	DESCRIZIONE/DESCRIPTION
M612000043	RAL	Eye verniciatura opaca anello RAL / Eye opaque painting frame ring RAL

<b>CONFEZIONE N° PCS/KIT:</b>	<b>25</b>	<b>MINIMO ACQUISTABILE:</b>	<b>1</b>
<b>PACKAGING N° PCS/KIT:</b>	<b>25</b>	<b>MINIMUM ORDER:</b>	<b>1</b>
<b>PESO DELLA CONFEZIONE:</b>	<b>0,55 kg</b>	<b>PESO DEL PEZZO KIT:</b>	<b>14 g</b>
<b>PACKAGING WEIGHT:</b>	<b>0,55 kg</b>	<b>KIT WEIGHT:</b>	<b>14 g</b>

## ANELLO

## CARATTERISTICHE GENERALI

**Materiale:** ABS autoestinguente UL94-V0

**Colore:** Verniciato a specifica RAL OPACO SOFT TOUCH

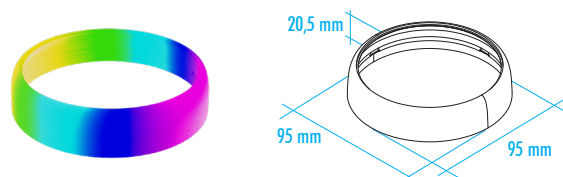

CODICE / CODE	COLORE / COLOUR	DESCRIZIONE/DESCRIPTION
M612000044	RAL	Eye verniciatura soft touch anello RAL / Eye painting soft touch frame ring RAL

<b>CONFEZIONE N° PCS/KIT:</b>	<b>25</b>	<b>MINIMO ACQUISTABILE:</b>	<b>1</b>
<b>PACKAGING N° PCS/KIT:</b>	<b>25</b>	<b>MINIMUM ORDER:</b>	<b>1</b>
<b>PESO DELLA CONFEZIONE:</b>	<b>0,55 kg</b>	<b>PESO DEL PEZZO KIT:</b>	<b>14 g</b>
<b>PACKAGING WEIGHT:</b>	<b>0,55 kg</b>	<b>KIT WEIGHT:</b>	<b>14 g</b>

ANELLO/RING

## GRAFICA

## CARATTERISTICHE GENERALI

Stampa di fondo in nero per display verticale 2,8", su pannello frontale trasparente

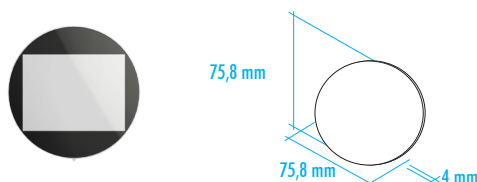

CODICE / CODE	DESCRIZIONE/DESCRIPTION
M612000046	Eye grafica rettangolare per TFT 2,8 " verticale e orizzontale / Eye rectangular graphics for TFT 2,8 " vertical and horizontal

<b>CONFEZIONE N° PCS/KIT:</b>	<b>25</b>	<b>MINIMO ACQUISTABILE:</b>	<b>1</b>
<b>PACKAGING N° PCS/KIT:</b>	<b>25</b>	<b>MINIMUM ORDER:</b>	<b>1</b>
<b>PESO DELLA CONFEZIONE:</b>	<b>0,50 kg</b>	<b>PESO DEL PEZZO KIT:</b>	<b>16 g</b>
<b>PACKAGING WEIGHT:</b>	<b>0,50 kg</b>	<b>KIT WEIGHT:</b>	<b>16 g</b>

GRAFICA/GRAPHIC

## GRAFICA CARATTERISTICHE GENERALI

Stampa di fondo in nero per display circolare Ø43 mm, su pannello frontale trasparente

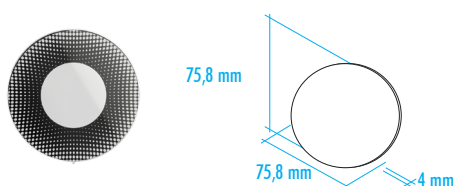

CODICE / CODE	DESCRIZIONE/DESCRIPTION
M612000047	Eye grafica circolare per TFT 2,8" Ø 43 mm bubble / Eye circular graphics TFT 2,8" Ø 43 mm bubble

## GRAPHIC GENERAL FEATURES

Black background printing for circular display Ø43 mm, front transparent panel use



<b>CONFEZIONE N° PCS/KIT:</b>	<b>25</b>	<b>MINIMO ACQUISTABILE: 1</b>	<b>1</b>
<b>PACKAGING N° PCS/KIT:</b>	<b>25</b>	<b>MINIMUM ORDER:</b>	<b>1</b>
<b>PESO DELLA CONFEZIONE:</b>	<b>0,50 kg</b>	<b>PESO DEL PEZZO KIT:</b>	<b>16 g</b>
<b>PACKAGING WEIGHT:</b>	<b>0,50 kg</b>	<b>KIT WEIGHT:</b>	<b>16 g</b>

## GRAFICA CARATTERISTICHE GENERALI

Stampa di fondo in nero per display circolare Ø43 mm, su pannello frontale trasparente

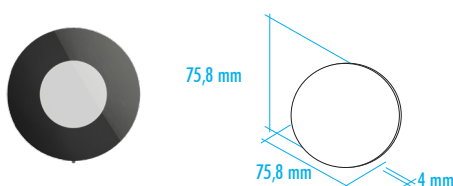

CODICE / CODE	DESCRIZIONE/DESCRIPTION
M612000048	Eye grafica circolare per TFT 2,8" Ø 43 mm / Eye circular graphics for TFT 2,8" Ø 43 mm

## GRAPHIC GENERAL FEATURES

Black background printing for circular display Ø43 mm, front transparent panel use



<b>CONFEZIONE N° PCS/KIT:</b>	<b>25</b>	<b>MINIMO ACQUISTABILE: 1</b>	<b>1</b>
<b>PACKAGING N° PCS/KIT:</b>	<b>25</b>	<b>MINIMUM ORDER:</b>	<b>1</b>
<b>PESO DELLA CONFEZIONE:</b>	<b>0,50 kg</b>	<b>PESO DEL PEZZO KIT:</b>	<b>16 g</b>
<b>PACKAGING WEIGHT:</b>	<b>0,50 kg</b>	<b>KIT WEIGHT:</b>	<b>16 g</b>

## GRAFICA CARATTERISTICHE GENERALI

Grafica per display circolare led 5 digit, su pannello frontale trasparente

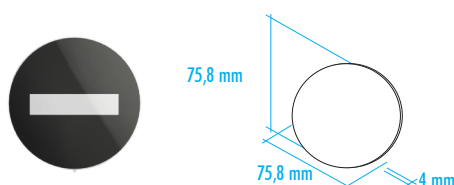

CODICE / CODE	DESCRIZIONE/DESCRIPTION
M612000049	Eye grafica per display led 5 digit / Eye graphics for display led 5 digits

## GRAPHIC GENERAL FEATURES

Graphic for display led 5 digits, for transparent front panel use



<b>CONFEZIONE N° PCS/KIT:</b>	<b>25</b>	<b>MINIMO ACQUISTABILE: 1</b>	<b>1</b>
<b>PACKAGING N° PCS/KIT:</b>	<b>25</b>	<b>MINIMUM ORDER:</b>	<b>1</b>
<b>PESO DELLA CONFEZIONE:</b>	<b>0,50 kg</b>	<b>PESO DEL PEZZO KIT:</b>	<b>16 g</b>
<b>PACKAGING WEIGHT:</b>	<b>0,50 kg</b>	<b>KIT WEIGHT:</b>	<b>16 g</b>

## GRAFICA CARATTERISTICHE GENERALI

Grafica per display circolare per 3 led Ø5 mm, da usare su pannello frontale 3 led

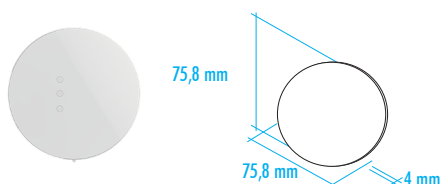

CODICE / CODE	DESCRIZIONE/DESCRIPTION
M612000050	eye grafica per 3 led Ø 5 mm / graphics for 3 led Ø 5 mm



CONFEZIONE N° PCS/KIT:	25
PACKAGING N° PCS/KIT:	25
PESO DELLA CONFEZIONE:	0,50 kg
PACKAGING WEIGHT:	0,50 kg

MINIMO ACQUISTABILE:	1
MINIMUM ORDER:	1
PESO DEL PEZZO KIT:	16 g
KIT WEIGHT:	16 g

## GRAFICA CARATTERISTICHE GENERALI

Grafica per dimmer con riferimenti posizionamento manopola, da usare su pannello frontale opaco bianco

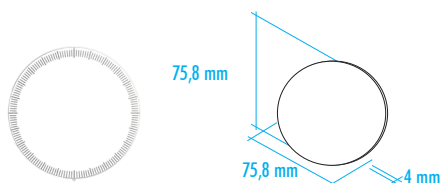

CODICE / CODE	DESCRIZIONE/DESCRIPTION
M612000051	Eye grafica per dimmer completa di rif per encoder e trimmer / Eye graphics for dimmer complete of ref. for encoder and trimmer



CONFEZIONE N° PCS/KIT:	25
PACKAGING N° PCS/KIT:	25
PESO DELLA CONFEZIONE:	0,50 kg
PACKAGING WEIGHT:	0,50 kg

MINIMO ACQUISTABILE:	1
MINIMUM ORDER:	1
PESO DEL PEZZO KIT:	16 g
KIT WEIGHT:	16 g

GRAFICA/GRAPHIC

## VITE CARATTERISTICHE GENERALI



CODICE / CODE	DESCRIZIONE/DESCRIPTION
PM10012001	Vite 2,2x4,5 TC+ / Screw 2,2x4,5 TC+



CONFEZIONE N° PCS/KIT:	1000
PACKAGING N° PCS/KIT:	1000
PESO DELLA CONFEZIONE:	0,07 kg
PACKAGING WEIGHT:	0,07 kg

MINIMO ACQUISTABILE:	1000
MINIMUM ORDER:	1000
PESO DEL PEZZO KIT:	0,06 g
KIT WEIGHT:	0,06 g

VITI/SCREWS

## VITE CARATTERISTICHE GENERALI

## SCREW GENERAL FEATURES



CODICE / CODE	DESCRIZIONE/DESCRIPTION
PMT0012003	Vite 2,2x6,5 TC + / Screw 2,2x6,5 TC +

CONFEZIONE N° PCS/KIT:	1000
PACKAGING N° PCS/KIT:	1000
PESO DELLA CONFEZIONE:	0,20 kg
PACKAGING WEIGHT:	0,20 kg

MINIMO ACQUISTABILE:	1000
MINIMUM ORDER:	1000
PESO DEL PEZZO KIT:	0,1 g
KIT WEIGHT:	0,1 g

VITI/SCREWS

## ACCESSORI CARATTERISTICHE GENERALI

**Materiale:** ABS autoestinguente UL94-V0  
**Colore:** Bianco  
Copriplacca rettangolare

## ACCESSORIES GENERAL FEATURES

**Material:** ABS self-extinguishing UL94-V0  
**Colour:** White  
Rectangular cover

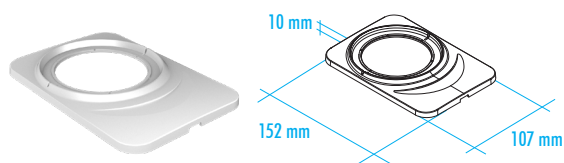

CODICE / CODE	COLORE / COLOUR	DESCRIZIONE/DESCRIPTION
P61610003A	Bianco/White	Eye copriplacca standard / Eye coverplate standard

CONFEZIONE N° PCS/KIT:	25
PACKAGING N° PCS/KIT:	25
PESO DELLA CONFEZIONE:	0,85 kg
PACKAGING WEIGHT:	0,85 kg

MINIMO ACQUISTABILE:	1
MINIMUM ORDER:	1
PESO DEL PEZZO KIT:	30 g
KIT WEIGHT:	30 g

## ACCESSORI CARATTERISTICHE GENERALI

**Materiale:** ABS autoestinguente UL94-V0  
**Colore:** Bianco  
Placca per fissaggio su scatola elettrica rettangolare 503, UK, USA oppure quadrata, Ø60 mm

## ACCESSORIES GENERAL FEATURES

**Material:** ABS self-extinguishing UL94-V0  
**Colour:** White  
Plate for rectangular electrical enclosure use type 3 gang, UK, USA or quadratik

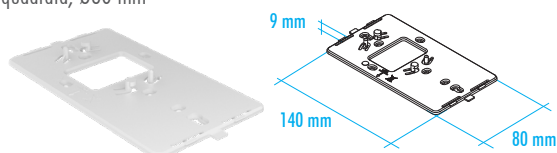

CODICE / CODE	COLORE / COLOUR	DESCRIZIONE/DESCRIPTION
P61610004A	Bianco/White	Eye placca per fissaggio a parete o scatola elettrica / Eye plate for wall fixing or electric enclosure

CONFEZIONE N° PCS/KIT:	25
PACKAGING N° PCS/KIT:	25
PESO DELLA CONFEZIONE:	0,60 kg
PACKAGING WEIGHT:	0,60 kg

MINIMO ACQUISTABILE:	1
MINIMUM ORDER:	1
PESO DEL PEZZO KIT:	20 g
KIT WEIGHT:	20 g

ACCESSORI/ACCESSORIES

ASSEMBLAGGIO/DISASSEMBLAGGIO

ASSEMBLY/DISASSEMBLY

MONTAGGIO/ASSEMBLY

EYE BOX SIMPLE

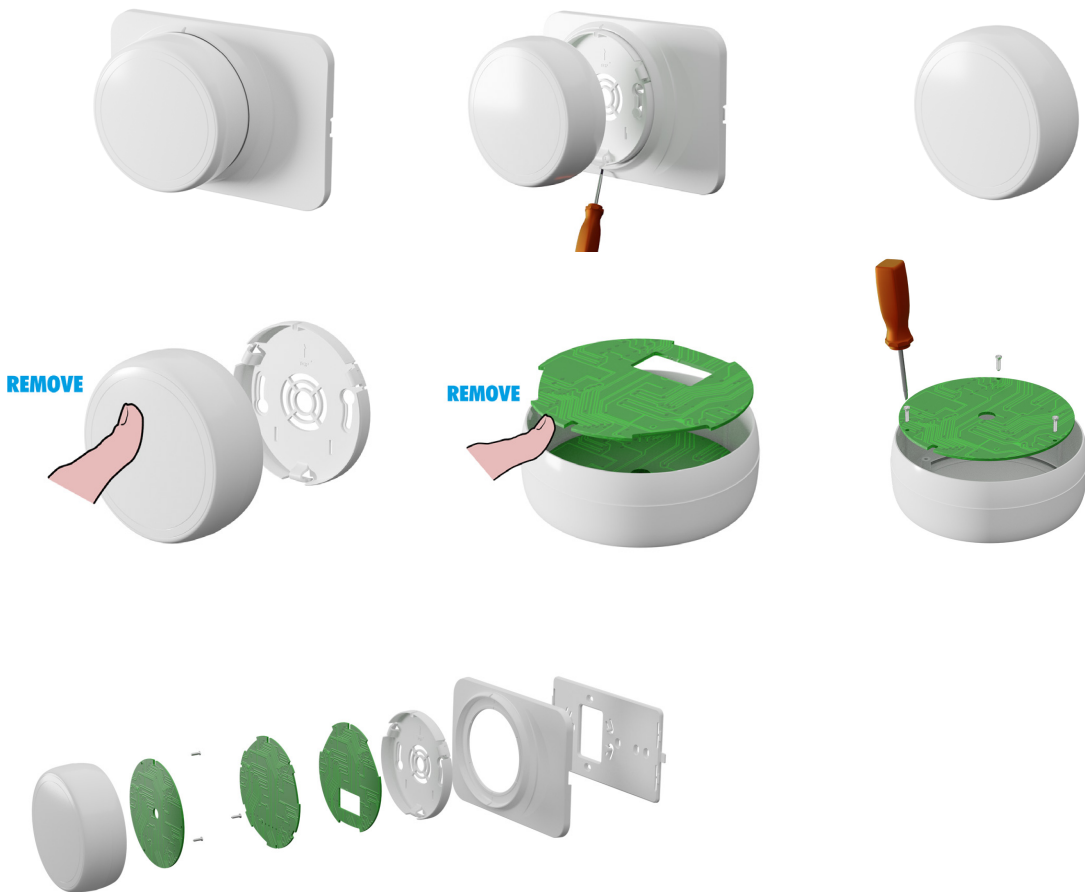
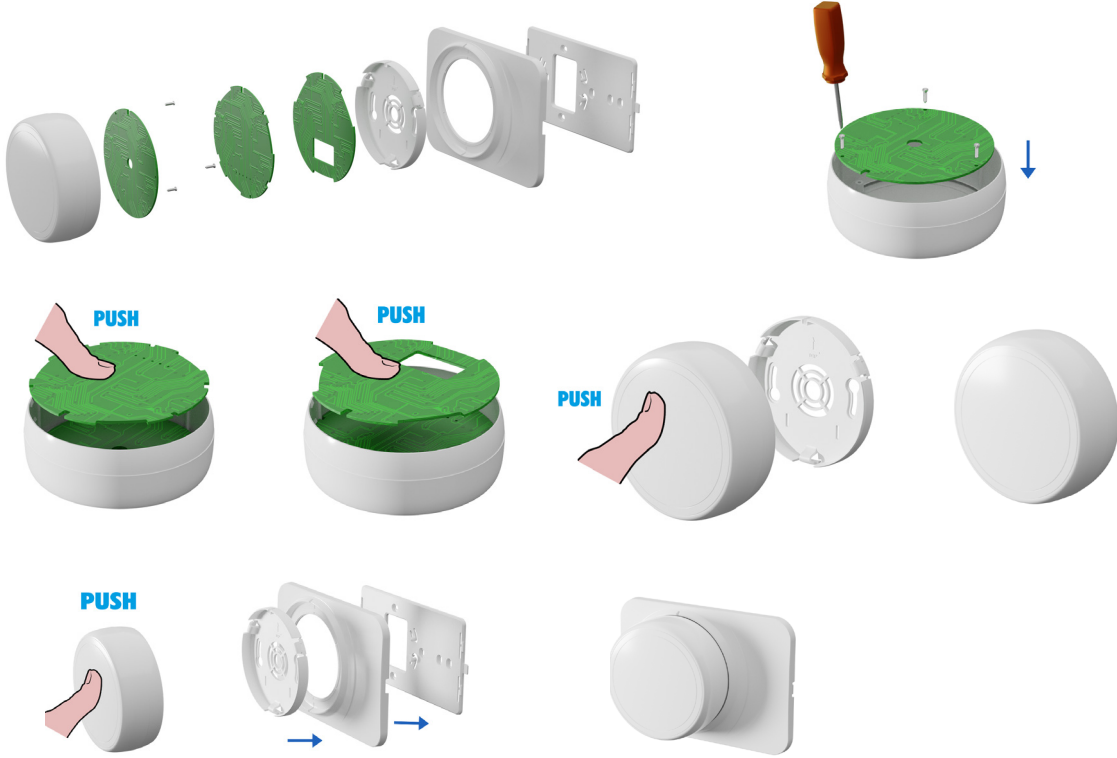

SMONTAGGIO/DISASSEMBLY



### EYEBOX SIMPLE

#### CARATTERISTICHE GENERALI

**Materiale:** ABS autoestinguente V0

**Colore:** Bianco

**Misure:** DIAM. 94,6 x H. 37,4 mm

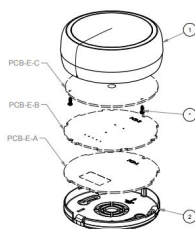

### EYEBOX SIMPLE

#### GENERAL FEATURES

**Material:** ABS autoestinguente V0

**Colour:** Bianco

**Dimension:** DIAM. 94,6 x H. 37,4 mm



**CODICE / CODE**

**DESCRIZIONE/DESCRIPTION**

61.6100001

Eyebox simple kit con base standard / Eyebox simple kit with standard base

**CONFEZIONE N° PCS/KIT:** 50  
**PACKAGING N° PCS/KIT:** 50  
**PESO DELLA CONFEZIONE:** 3,8 kg  
**PACKAGING WEIGHT:** 3,8 kg

**MINIMO ACQUISTABILE:** 1  
**MINIMUM ORDER:** 1  
**PESO DEL PEZZO KIT:** 58 g  
**KIT WEIGHT:** 58 g

### EYEBOX SIMPLE

#### CARATTERISTICHE GENERALI

**Materiale:** ABS autoestinguente V0

**Colore:** Bianco

**Misure:** DIAM. 94,6 x H. 37,4 mm

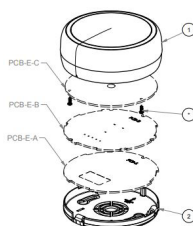

**CODICE / CODE**

**DESCRIZIONE/DESCRIPTION**

61.6100002

Eyebox simple kit con base per CSF / Eyebox simple kit with CSF base

**CONFEZIONE N° PCS/KIT:** 50  
**PACKAGING N° PCS/KIT:** 50  
**PESO DELLA CONFEZIONE:** 3,8 kg  
**PACKAGING WEIGHT:** 3,8 kg

**MINIMO ACQUISTABILE:** 1  
**MINIMUM ORDER:** 1  
**PESO DEL PEZZO KIT:** 58 g  
**KIT WEIGHT:** 58 g

### EYEBOX SIMPLE

#### ESEMPI DI VERSIONI SPECIALI SU RICHIESTA CON IMDT



### EYEBOX SIMPLE

#### SPECIAL VERSIONS EXAMPLES ON DEMAND WITH IMDT

### EYEBOX SIMPLE

#### ESEMPI DI LAVORAZIONI CNC



### EYEBOX SIMPLE

#### CNC LAVORATIONS EXAMPLES



## VITE CARATTERISTICHE GENERALI

## SCREW GENERAL FEATURES



CODICE / CODE	DESCRIZIONE/DESCRIPTION
PM10012003	Vite 2,2x6,5 TC+ / Screw 2,2x6,5 TC+

CONFEZIONE N° PCS/KIT:	1000
PACKAGING N° PCS/KIT:	1000
PESO DELLA CONFEZIONE:	0,20 kg
PACKAGING WEIGHT:	0,20 kg

MINIMO ACQUISTABILE:	1000
MINIMUM ORDER:	1000
PESO DEL PEZZO KIT:	0,1 g
KIT WEIGHT:	0,1 g

VITI/SCREWS

## ACCESSORI CARATTERISTICHE GENERALI

**Materiale:** ABS autoestinguente UL94-V0

**Colore:** Bianco

Copriplacca rettangolare

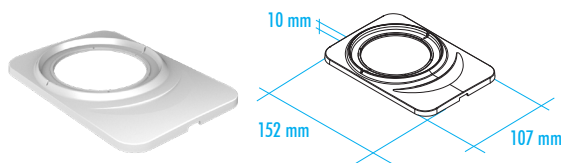

## ACCESSORIES GENERAL FEATURES

**Material:** ABS self-extinguishing UL94-V0

**Colour:** White

Rectangular cover



CODICE / CODE	COLORE / COLOUR	DESCRIZIONE/DESCRIPTION
P61610003A	Bianco/White	Eye copriplacca standard / Eye coverplate standard

CONFEZIONE N° PCS/KIT:	25
PACKAGING N° PCS/KIT:	25
PESO DELLA CONFEZIONE:	0,85 kg
PACKAGING WEIGHT:	0,85 kg

MINIMO ACQUISTABILE:	1
MINIMUM ORDER:	1
PESO DEL PEZZO KIT:	30 g
KIT WEIGHT:	30 g

## ACCESSORI CARATTERISTICHE GENERALI

**Materiale:** ABS autoestinguente UL94-V0

**Colore:** Bianco

Placca per fissaggio su scatola elettrica rettangolare 503, UK, USA oppure quadrata, Ø60 mm

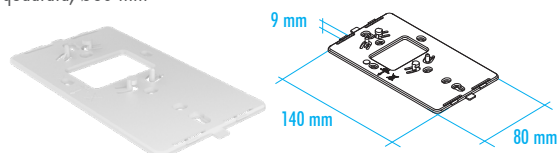

## ACCESSORIES GENERAL FEATURES

**Material:** ABS self-extinguishing UL94-V0

**Colour:** White

Plate for rectangular electrical enclosure use type 3 gang, UK, USA or quadratik



CODICE / CODE	COLORE / COLOUR	DESCRIZIONE/DESCRIPTION
P61610004A	Bianco/White	Eye placca per fissaggio a parete o scatola elettrica / Eye plate for wall fixing or electric enclosure

CONFEZIONE N° PCS/KIT:	25
PACKAGING N° PCS/KIT:	25
PESO DELLA CONFEZIONE:	0,60 kg
PACKAGING WEIGHT:	0,60 kg

MINIMO ACQUISTABILE:	1
MINIMUM ORDER:	1
PESO DEL PEZZO KIT:	20 g
KIT WEIGHT:	20 g

ACCESSORI/ACCESSORIES

## FINISHING SERVICE

ITALTRONIC è da tempo impegnata nella fornitura dei propri contenitori completi di servizi aggiuntivi vari per il completamento dei prodotti esteticamente e meccanicamente. Per fare ciò si è dotato di un ufficio tecnico che può tradurre le note della clientela in disegni esecutivi prima e in campionature per la valutazione finale della corrispondenza al progetto.

Alcuni servizi sono completamente GRATUITI, cioè quando il cliente fornisce dei documenti tecnici già conformi al post process che ITALTRONIC dovrà fare, altri invece sono a pagamento: generalmente quando ITALTRONIC deve sviluppare un progetto sui propri contenitori oppure adattare le informazioni ricevute agli STANDARD necessari per avviare la produzione.

Qui di seguito troverete una semplice traccia di quelle che sono le richieste minime di ITALTRONIC affinché la gestione possa essere veloce, semplice e gratuita, fatto salvo i costi di attrezzatura di base; altrimenti saranno addebitati i costi relativi alle attività svolte dai tecnici ITALTRONIC al puro costo aziendale.

### PERSONALIZZAZIONE MECCANICA

Stiamo in grado di fornire un servizio di personalizzazione meccanica del prodotto con l'ausilio di macchine per fresatura CNC, taglio e tranciatura.

**Lavorazioni meccaniche su superfici:** ABS, PC/ABS, PPO, PC, PMMA, PA

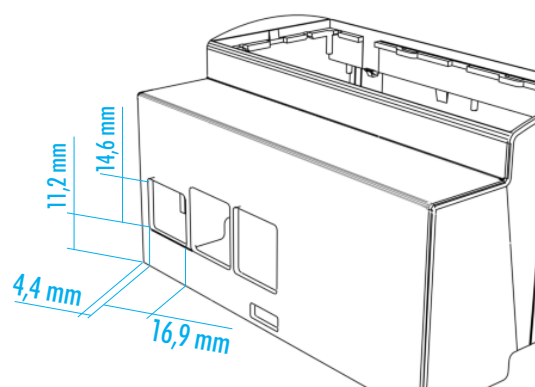

### SPECIFICHE TECNICHE RICHIESTE

**File:** .dwg, .dxf o STEP

**Dimensioni:** Scala 1:1

In caso contrario, verranno addebitati i costi in base alla complessità nel creare un file di lavorazione. Come modello per la creazione di un file abbiamo bisogno di un disegno/schizzo che contenga tutte le dimensioni di lavorazione pertinenti.

EXTRA COST



OK



EXTRA COST



### SPECIFICHE TECNICHE GARANTITE

#### Centraggio delle lavorazioni

La centratura di tutte le lavorazioni eseguite da Italtronic è sottoposta a un controllo finale con uno strumento semplice come il calibro.

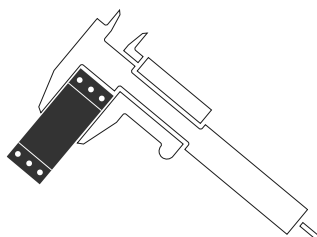

## FINISHING SERVICE

For years ITALTRONIC has been working to supply its enclosures with the various additional services to complete the products both externally and mechanically. To do this, we have set up our technical office that is able to translate our customers' notes into initial project drawings and samples to enable a final evaluation of whether they correspond to the project.

Some services are FREE OF CHARGE, i.e. when the customer gives us the technical documents that already conform to the post processing ITALTRONIC has to do, while others are for a fee: usually when ITALTRONIC has to develop a project on its own enclosures, or adapt the information received to the necessary production STANDARDS.

Below you will find a simple guide of the ITALTRONIC minimum requests so that the process can be quick, simple and free, apart from the basic equipment costs, otherwise we will charge you for the work of our ITALTRONIC technicians at the pure cost price.

### MECHANICAL PERSONALIZATION

We can supply a product mechanical personalization service with the aid of milling, CNC, cutting and trenching machines.

**Mechanical processing:** on ABS, PC/ABS, PPO, PC, PMMA, PA surfaces

### TECHNICAL SPECS REQUEST

**File:** .dwg, .dxf o STEP

**Dimensions:** 1:1 scale

Otherwise, additional costs will be charged, according to the complexity of the print file preparation. As guideline for the final print file, we need to have a drawing / sketch showing all pertinent working dimensions.

### GUARANTEED TECHNICAL SPECS

#### Centring the work

The centring for all the work by Italtronic undergoes a final control using a simple tool, like a gauge.

### COME QUOTARE E CONTROLLARE LE MISURE DELLE LAVORAZIONI

Qui sotto riportiamo un esempio di come possono essere eseguite delle misure affinché risultino centrate con altri processi, come quello di STAMPA, e siano ortogonali ai piani di riferimento dei nostri prodotti.

### HOW TO QUOTE AND TO CHECK THE MACHINING DIMENSIONS

Below is an example of how the measurements can be taken so that they are centred with other processes, such as PRINT, and are at right angles to the reference surfaces of our products.

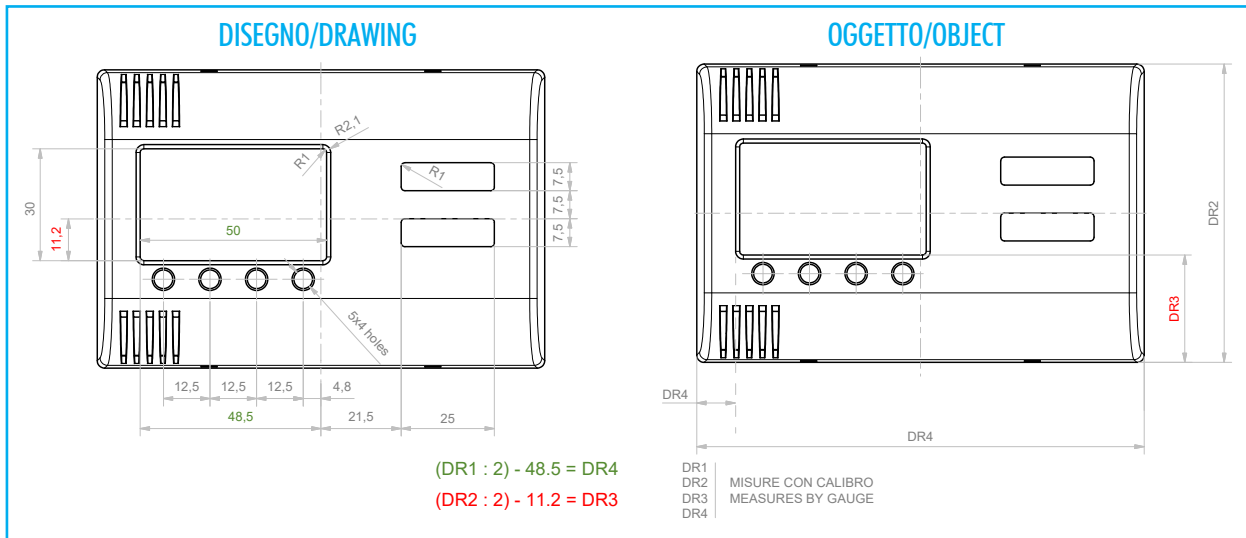

### SVASATURE E RIBASSI

ITALTRONIC offre un ottimo servizio di finitura meccanica adatta a migliorare l'estetica del prodotto, con svasature e ribassi.

### FLARING & LOWERING

ITALTRONIC offers a very good mechanical Finishing Service for a better aesthetics result of the products, with flaring and lowering.

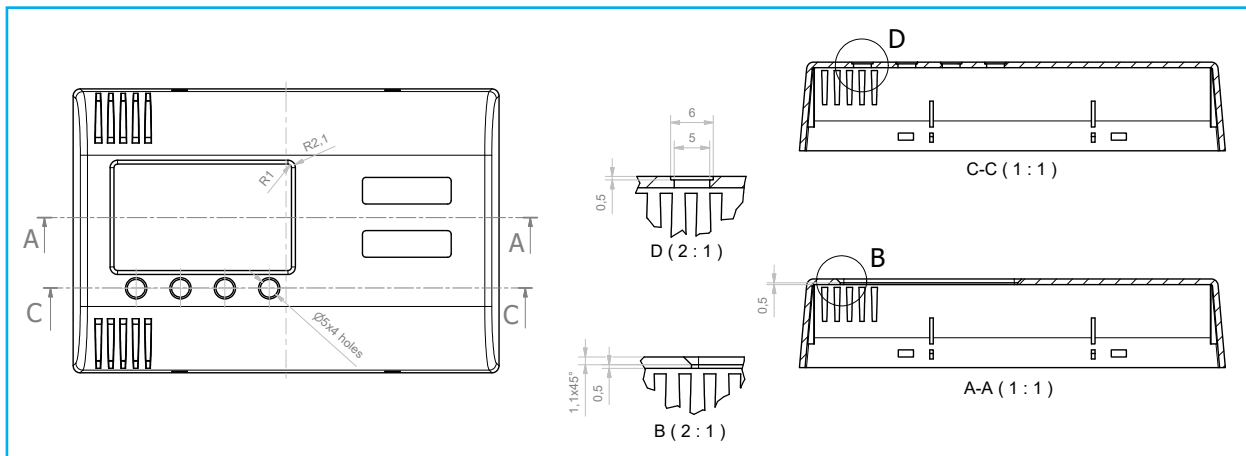

Le tolleranze dimensionali possono essere ristrette se indicate nel disegno del cliente e se compatibili con i nostri processi produttivi: la fornitura del nostro disegno controfirmata fa da garanzia.

The size tolerances can be less if they are indicated in the customer's drawing and are compatible with our production processes: the supply of our countersigned drawing guarantees this.

### Tolleranze dimensionali/Tolerance limits

Secondo tolleranze generali UNI EN 22768/1 media (m):

Average tolerances as per UNI EN 22768/1 medium (m):

DA 0.5 A 3 mm/FROM 0.5 TO 3mm	±0.1 mm
DA 3 FINO A 6 mm/FROM 3 TO 6mm	±0.1 mm
OLTRE 6 FINO A 30 mm/BEYOND 6 AND UP TO 30 mm	±0.2 mm
OLTRE 30 FINO A 120 mm/BEYOND 30 AND UP TO 120 mm	±0.3 mm
OLTRE 120 FINO A 400 mm/BEYOND 120 AND UP TO 400 mm	±0.5 mm

**PERSONALIZZAZIONE GRAFICA**

ITALTRONIC fornisce un ottimo servizio di personalizzazione grafica sui propri prodotti. È opportuno prendere visione delle note più sotto per ottenere risposte veramente veloci e costi ridotti al minimo.

**Nota:** Tutti i contenuti devono essere modificabili (generalmente i file non vettoriali non sono modificabili)

In caso contrario, verranno addebitati i costi in base alla complessità nel creare un file di stampa. Per la creazione di un file di stampa a partire da zero abbiamo bisogno di un disegno / schizzo che contenga tutte le dimensioni di lavorazione pertinenti. Se non è possibile fornire i loghi, i simboli (come file di immagine, ad es. Jpg con risoluzione min. 1200 dpi) o eventuali caratteri speciali, sono possibili lievi non conformità.

**DOCUMENTAZIONE TECNICA RICHIESTA DA ITALTRONIC**

**File di stampa ottimale:** layout deve sempre essere una grafica vettoriale (no grafica raster) in formato Adobe Illustrator, EPS, file .pdf vettoriale o Corel Draw.

**GRAPHIC PERSONALIZATION**

ITALTRONIC provides an excellent customised graphic service on its products. Read the notes below for a quick answer and costs reduced to the minimum.

**Note:** All contents must be editable (non-vector files usually cannot be modified)

Otherwise, additional costs will be charged, according to the complexity of the print file preparation. In order to create a print file from scratch, we need to have a drawing / sketch showing all pertinent working dimensions. If it is not possible to supply logos, symbols (in image-format files, such as jpg, with a minimum resolution of 1200 dpi) as well as any special non-standard characters, slight differences should be expected.

**TECHNICAL DOCUMENTATION REQUIRED BY ITALTRONIC**

**Optimal print file:** the layout must always be a vector graphic (no raster graphic) in Adobe Illustration EPS format, vector PDF or Corel Draw.

EXTRA COST



OK



EXTRA COST



Nel caso in cui parte del file (o tutto il file non sia vettoriale, potremo accettare file con le caratteristiche: scala 1:1, inclusi file di immagine, ad esempio jpg o bmp risoluzione minima 1200 dpi.

In case part of the file (or the entire file) is not a vector graphic, we may consider files having the following characteristics: scale 1:1, including image files such as jpg or bmp, 1200 dpi minimal resolution.



**Nota:** Esempio file immagine alta risoluzione (1200 dpi)  
**Note:** High resolution image file example (1200 dpi)

**Nota:** Esempio file immagine bassa risoluzione (<1200 dpi)  
**Note:** Low resolution image file example (<1200 dpi)

**SPECIFICHE TECNICHE GARANTITE**

**CENTRAGGIO DELLE STAMPE**

La centratura di tutte le lavorazioni eseguite da ITALTRONIC è sottoposta a un controllo finale con uno strumento semplice come il calibro.

Qui sotto riportiamo un esempio di come possono essere eseguite delle misure affinché risultino centrate con altri processi, come quello di CNC, e siano ortogonali ai piani di riferimento dei nostri prodotti.

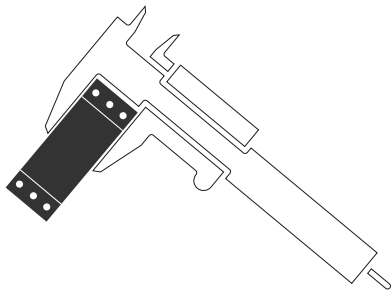

Le tolleranze possono essere ristrette se indicate nel disegno del cliente e se compatibili con i nostri processi produttivi: la fornitura del nostro disegno controfirmato fa da garanzia.

**GUARANTED TECHNICAL SPECS**

**PRINTING CENTRING**

The centring for all the work by Italtronic undergoes a final control using a simple tool, like a gauge.

Below is an example of how the measurements can be taken so that they are centred with other processes, such as CNC, and are at right angles to the reference surfaces of our products.

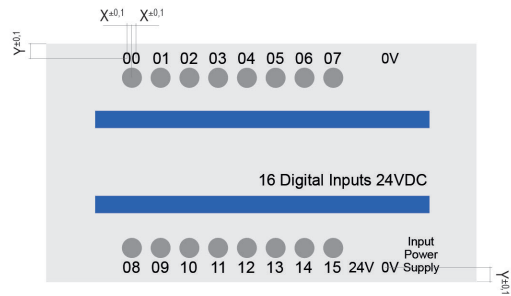

The size tolerances can be less if they are indicated in the customer's drawing and are compatible with our production processes: the supply of our countersigned drawing guarantees this.

**Tolleranze dimensionali/Tolerance limits**

Con stampa di forma (mm) secondo tolleranze generali UNI EN 22768/1 media (m):

With dye (mm) printing having average tolerances as per UNI EN 22768/1 medium (m):

DA 0.5 A 3 mm/FROM 0.5 TO 3 mm	±0.1 mm
DA 3 FINO A 6 mm/FROM 3 TO 6 mm	±0.1 mm
OLTRE 6 FINO A 30 mm/BEYOND 6 AND UP TO 30 MM	±0.2 mm
OLTRE 30 FINO A 120 mm/BEYOND 30 AND UP TO 120 mm	±0.3 mm
OLTRE 120 FINO A 400 mm/BEYOND 120 AND UP TO 400 mm	±0.5 mm
VARIAZIONI PERMESSE/PERMITTED VARIATIONS	Ampiezza della linea ± 10%/Line extent ± 10%
TOLLERANZA DI SPAZI VUOTI/EMPTY SPACE TOLERANCE	Contorno esterno e ritagli (mm) ± 0.3*/External contour and cropping (mm) ± 0.3*

## STAMPA DIGITALE

La stampa digitale è particolarmente indicata quando sono richiesti molti colori, sfumature e tempi rapidi di esecuzione con costi contenuti; per quantità da basse a medio alte.

Il processo di stampa digitale UV con qualità fotografica permette facilmente di poter avere la massima flessibilità per realizzare qualsiasi tipo di grafica a più colori ad un prezzo competitivo anche per piccoli lotti.

Si tratta di una stampa in quadricromia a getto d'inchiostro successivamente catalizzato a mezzo UV, con una dimensione dei pixel molto ridotta che però non consente di ottenere esattamente la tonalità di colore richiesta (scala RAL o PANTONE).

### SPECIFICHE TECNICHE:

**Superfici:** Stampa su ABS, PC/ABS, PPO, PC, PMMA, PA

**Profondità massima:** 1,5 mm

**Colori:** CMYK + bianco

**Risoluzione:** fino a 1440x1200 dpi

**Formato massimo di stampa:** 297x420 mm



## STAMPA TAMPOGRAFICA

La stampa tampografica è consigliata quando è sufficiente un solo colore e la profondità (scalino) di stampa è superiore a 1,5 mm.

È un procedimento di stampa indiretto, che permette di riprodurre, in modo semplice con elevata fedeltà e risoluzione disegni, scritte e decori sia su superfici piane che su superfici concave, convesse o comunque irregolari. Consigliamo l'impiego di questa tecnologia fino ad un massimo di 2 colori (esempio pannello a 1 o 2 colori) su nostri coprimorsetti, contenitori e anche pannelli.

### SPECIFICHE TECNICHE:

**Superfici:** Stampa su ABS, PC/ABS, PPO, PC, PMMA, PA

**Colori:** Tutti

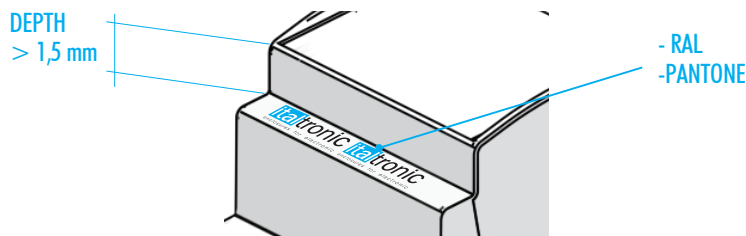

## STAMPA SERIGRAFICA

È una tecnologia consolidata di stampa industriale, molto utilizzata in tutte le applicazioni in cui sia richiesto un deposito di inchiostro più elevato rispetto ad altre tecnologie di stampa su superfici piane. Il principio per cui una racle spingendo un inchiostro o una pasta attraverso una maglia aperta di un tessuto tecnico ne ottiene un passaggio uniforme e controllato.

### SPECIFICHE TECNICHE:

**Superfici:** Stampa su ABS, PC/ABS, PPO, PC, PMMA, PA

**Colori:** Tutti

## MARCATURA LASER

Consente l'identificazione permanente (monocromatica) del prodotto anche con tratti molto sottili.

### SPECIFICHE TECNICHE:

**Superfici:** Stampa su ABS, PC/ABS, PPO

**Colori:** Colore a contrasto a seconda del tipo di materiale

## DIGITAL PRINT

Digital printing is ideal when a lot of colours are involved, with shading and fast production with limited costs; for small, medium and large quantities.

The UV digital print process with photographic quality allows maximum flexibility in the realization of any type of graphic in several colours and at a very competitive price, even for small quantities.

It is an inkjet four-colour printing method subsequently catalysed by UV, with a consistently reduced pixel size which, on the other hand, does not guarantee exact colour tonality reproduction (RAL table or pantone).

### TECHNICAL SPECS:

**Surfaces:** Print on ABS, PC/ABS, PPO, PC, PMMA, PA

**Maximum depth:** 1,5 mm

**Colours:** CMYK + white

**Resolution:** up to 1440x1200 dpi

**Maximum print size:** 297x420 mm

## PAD PRINTING

Pad printing is recommended when just one colour is sufficient and the printing depth (step) is more than 1.5 mm.

It is an indirect printing process, which allows reproducing high-fidelity and high resolution drawings, writings and decors, on either flat, concave, convex or anyway irregular surfaces. We suggest this technology for prints up to 2 colour (e.g. a panel in 1 or 2 colours) on our terminal covers, containers and panels, too.

### TECHNICAL SPECS:

**Surfaces:** Print on ABS, PC/ABS, PPO, PC, PMMA, PA

**Colours:** All

## SERIGRAPHY PRINTING

It is a consolidated industrial print system, very much used in all applications requiring thicker ink layers in comparison with other flat-surface print technologies. The principle consists in a blade pushing the ink or paste through hollow tangles of technical fabrics, obtaining a controlled and uniform result.

### TECHNICAL SPECS:

**Surfaces:** Print on ABS, PC/ABS, PPO, PC, PMMA, PA

**Colours:** all

## LASER ENGRAVING

Allows permanent identification (monochrome) of the product, even with very thin strokes.

### TECHNICAL SPECS:

**Surfaces:** Print on ABS, PC/ABS, PPO

**Colours:** Contrasting colour depending on the material type

## Riproducibilità del colore/Colour reproducibility

	SERIGRAFIA/SERIGRAPHY	TAMPOGRAFIA/PAD-PRINTING	DIGITALE/ DIGITAL
FEDELTÀ/ FIDELITY	90%	90%	100%
COLORE CAMPIONE/SAMPLE COLOUR	100%	100%	60%

# Note

EYE BOX

A series of horizontal dashed lines for writing notes, spanning the width of the page.

# Note

## EYE BOX

A series of horizontal dashed lines for writing notes, spanning the width of the page.

**italtronic**  
enclosures for electronics

**Italtronic Srl**

Corso Stati Uniti 17  
35127 Padova - Italy  
T. +39 049 8947150  
F. +39 049 8947151  
[www.italtronic.com](http://www.italtronic.com)

