

A WORLD OF ENCLOSURES

iTouch

SHORT FOLDER

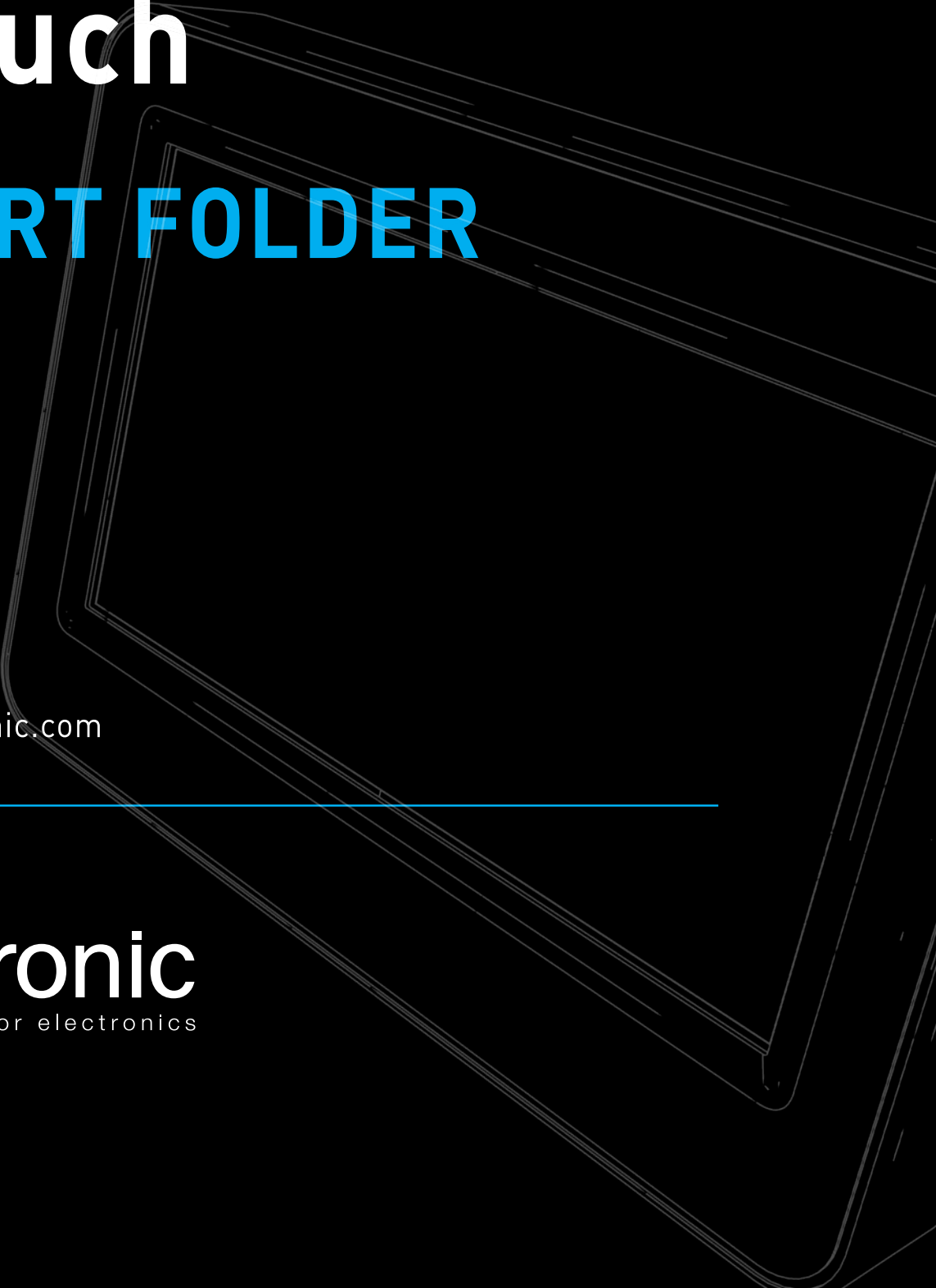

www.italtronic.com

italtronic
enclosures for electronics



CARATTERISTICHE GENERALI

Contenitore per Domotica 80x120x10; 15; 25

Materiale: ABS autoestinguente

La linea iTouch è adatta per molteplici applicazioni ed è suddivisa in tre estetiche principali: iShape, std Shape e CSF.

La prima estetica denominata iShape è quella più flessibile perché accetta sul frontale diversi tipi di pannello: plastico, in vetro o con funzione touch panel integrata.

La seconda versione, STD Shape, è quella più semplice perché non è necessario l'impiego di un pannello ma è sufficiente l'equipaggiamento con il display con funzione touch panel integrato.

L'ultima, denominata CSF è invece più simile alle applicazioni tradizionali, con colori e materiali coordinati e il pannello anteriore cieco adatto a lavorazioni meccaniche e stampa; può essere equipaggiato con manopole.

Tutti e tre i modelli possono essere completati, nella parte posteriore, con accessori per fissaggio su scatole elettriche di vario tipo, a parete o palmare (CSF solo su richiesta).

GENERAL FEATURES

Enclosure for Domotics 80x120x10; 15; 25

Material: ABS self-extinguishing

The iTouch range is suitable for several applications and is subdivided into three main aesthetics: iShape, STD shape, and CSF.

The first aesthetic called iShape is the most flexible one because it accepts several types of panels on the front, plastic, glass or with integrated touch panel functions.

The second version, STD shape, is the most simple one because it is not necessary the use of a panel but it is enough the equipment with DISPLAY with touch panel integrated function.

The last one, called CSF, is instead more similar to the traditional applications with coordinate colours and front panel closed, suitable to mechanical machinings and printing; it can be equipped with knobs.

All three models can be completed, in the rear part, with fastening accessories on various types of electric enclosures, wall mounting or handheld enclosures (CSF only on request).

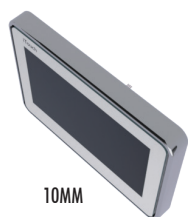

10MM

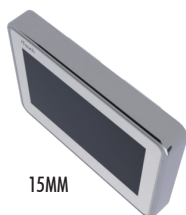

15MM

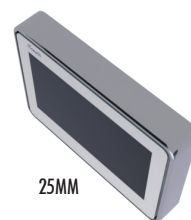

25MM



WHITE



BLACK



503



D.60



WHITE CHROME



BLACK CHROME



HANDHELD

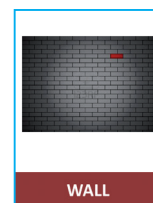

WALL



iShape iTouch

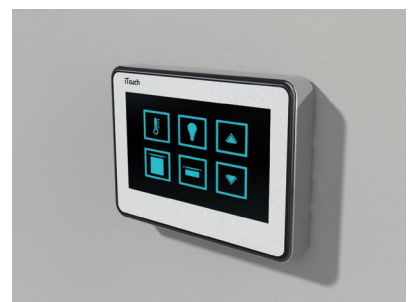
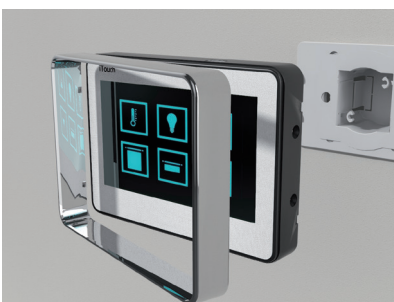
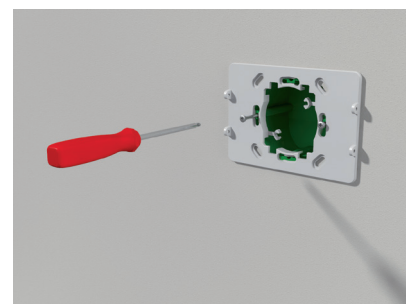
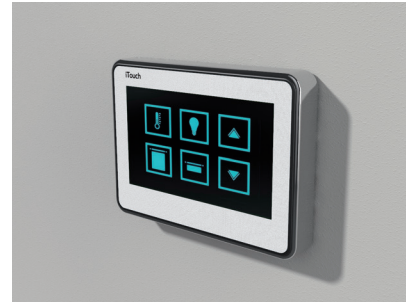
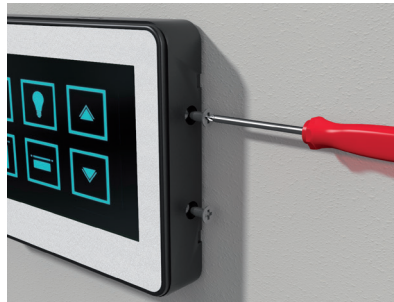
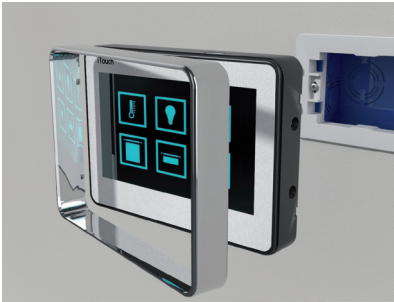
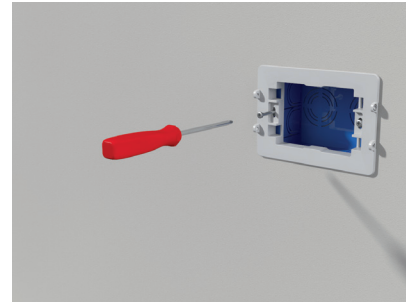
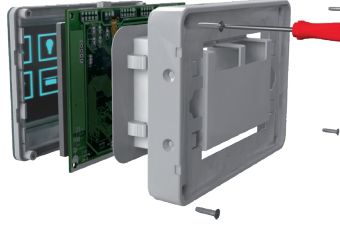
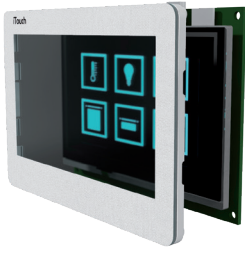

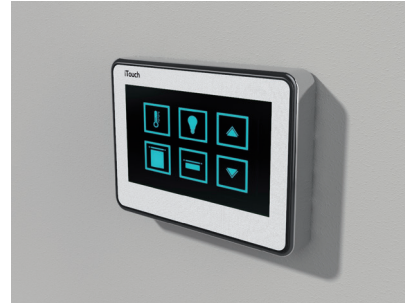
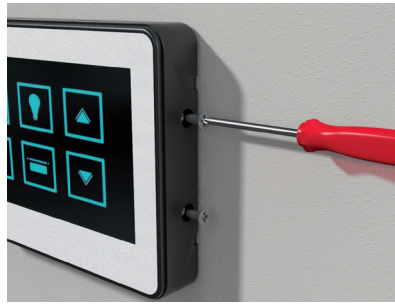
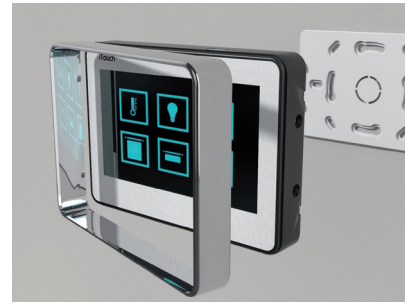
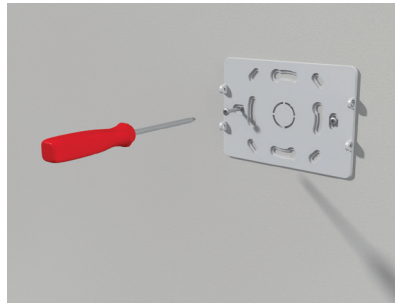
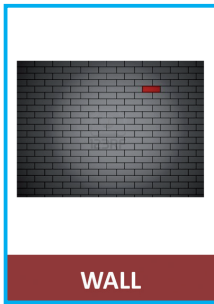

CSF Solo versione 25 mm / Only 25 mm version

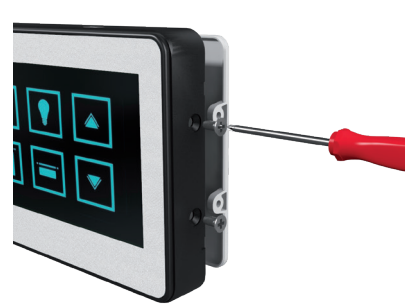
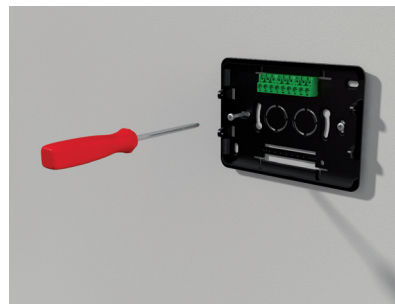
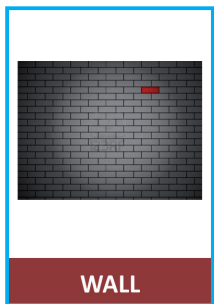

HOW TO ORDER iTouch

iShape/STD shape



①

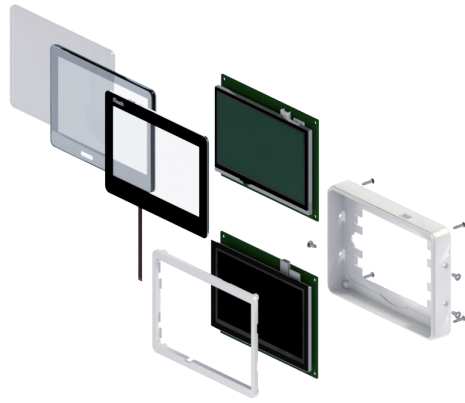

②

ORDINA IN TRE PASSI

1. Scegli la cornice anteriore da associare all'estetica che preferisci iShape oppure STD Shape.
2. Scegli il kit corpo contenitore con colore abbinato alla cornice anteriore. Devi acquistare anche il pannello touch nel colore abbinato solo se hai scelto la forma iShape. La scheda elettronica deve essere ordinata in accordo con l'estetica scelta. Italtronic fornisce su richiesta i nomi dei produttori e rispettivi data sheet.
3. Scegli la finitura posteriore in accordo con l'applicazione che devi sviluppare: per scatola elettrica 503, per scatola elettrica DIAM 60, per assemblaggio diretta a parete piatta oppure per uso palmare.

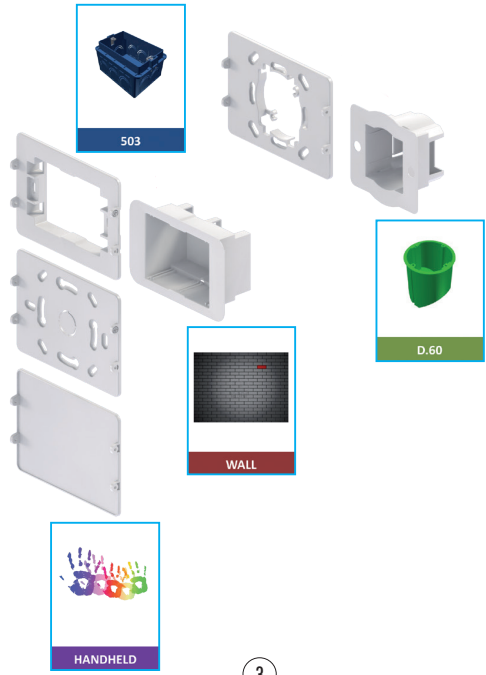

③

THREE STEPS ORDER

1. Choose the front frame to match with the aesthetic that you prefer, iShape or Standard shape.
2. Choose the body case kit with colour matching the front frame. You have to buy also the touch panel in the colour-matching only if you have chosen the iShape. The electronic card must be ordered according to the chosen aesthetic. Italtronic supplies the name of the producers and relative datasheets on request.
3. Choose the rear finishing according to the application that you have to develop: for electric case 503, for electric case DIAM 60, for direct assembling on flat wall or for handheld use.



①



②

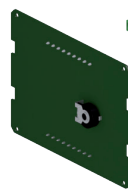

③

ORDINA IN POCHI PASSI

1. Scegli la cornice anteriore da associare all'estetica che preferisci.
2. Scegli il kit corpo contenitore con colore abbinato.
3. Scegli le eventuali manopole o chiedi la foratura per posizionare le manopole dove ritieni opportuno.

ORDER IN A FEW STEPS

1. Choose the front frame to match with the aesthetic you prefer .
2. Choose the body case kit with colour- matching.
3. Choose the eventual knobs or ask for a milling to place the knobs where it is more appropriate for you.

CSF

INDICE/INDEX

ANELLI CORNICE / FRAME RINGS



P14001305A Anelli cornice H10
Frame rings H10 PAG 16



P14001105A Anelli cornice H10
Frame rings H10 PAG 16



P14001135A Anelli cornice H10
Frame rings H10 PAG 16



P14002305A Anelli cornice H15
Frame rings H15 PAG 16



P14002105A Anelli cornice H15
Frame rings H15 PAG 16



P14002135A Anelli cornice H15
Frame rings H15 PAG 16



P14003305A Anelli cornice H25
Frame rings H25 PAG 16



P14003105A Anelli cornice H25
Frame rings H25 PAG 16



P14003135A Anelli cornice H25
Frame rings H25 PAG 16

PANNELLI FRONTALI / FRONT PANELS



P14033700V Pannello in vetro frontale trasparente
Transparent glass front panel PAG 17



P14023700V Pannello in vetro frontale fumè
Smoked glass front panel PAG 17



P14013700V Pannello in vetro frontale specchio
Mirror glass front panel PAG 17



PANNELLO TOUCH RESISTIVO / TOUCH RESISTIVE PANEL

14.TP10000 Pannello touch resistivo frontale nero
Black front touch resistive panel PAG 17



14.TP30000 Pannello touch resistivo frontale bianco
White front touch resistive panel PAG 17



14.TP00000 Pannello touch resistivo frontale neutro
Neutral front touch resistive panel PAG 17

PANNELLO IN POLICARBONATO / POLYCARBONATE PANEL



P140013749 Pannello in policarbonato trasparente frontale
Polycarbonate front transparent panel PAG 17

PANNELLO CHIUSO / CLOSED PANEL



P140023749 Pannello plastico frontale chiuso bianco
Plastic white front panel closed PAG 18



P140033749 Pannello plastico frontale chiuso nero
Plastic black front panel closed PAG 18

KIT CONTENITORE / ENCLOSURE KIT



14.3201310 Kit contenitore H10
Enclosure kit H10 PAG 18



14.3201110 Kit contenitore H10
Enclosure kit H10 PAG 18



14.3211310 Kit contenitore H10 con inseritore card
Enclosure kit H10 with card slot PAG 19



14.3211110 Kit contenitore H10 con inseritore card
Enclosure kit H10 with card slot PAG 19



14.3201315 Kit contenitore H15
Enclosure kit H15 PAG 18



14.3201115 Kit contenitore H15
Enclosure kit H15 PAG 18



14.3201325 Kit contenitore H25
Enclosure kit H25 PAG 19



14.3201125 Kit contenitore H25
Enclosure kit H25 PAG 19

KIT CONTENITORE CHIUSO H25 / CLOSED ENCLOSURE KIT H25



14.3203325 Kit contenitore H25
Enclosure kit H25 PAG 19



14.3203125 Kit contenitore H25
Enclosure kit H25 PAG 19

KIT PLACCA POSTERIORE / MOUNTING FRAME KIT



14.3205001 Kit placca posteriore per scatola elettrica tipo 503
Mounting frame kit for electrical enclosure 503 / 3 gang PAG 20



14.3205002 Kit placca posteriore per scatola elettrica tipo D60 mm o 70x70 UK
Mounting frame kit for electrical enclosure D60 type or 70x70 UK PAG 20



14.3205003 Kit placca posteriore per montaggio a parete o per scatola elettrica
Mounting frame kit for wall mounting or for electrical enclosure PAG 20



14.3205011 Kit placca posteriore per scatola Ø60 H20
Mounting frame kit for Ø60 H20 box PAG 21



14.3205012 Kit placca posteriore per scatola Ø60 H20 KNX
Mounting frame kit for Ø60 H20 box KNX PAG 21



14.3205021 Kit placca posteriore per scatola 503 H20
Mounting frame kit for 503 H20 box PAG 21



14.3205024 Kit placca posteriore per scatola 503 H20 KNX
Mounting frame kit for 503 H20 box KNX PAG 22



14.3205004 Kit placca posteriore per uso palmare nero
Black mounting frame kit for handle use PAG 22



14.3205005 Kit placca posteriore per uso palmare bianco
White mounting frame kit for handle use PAG 22

INDICE/INDEX

iShape

KIT PLACCA POSTERIORE / MOUNTING FRAME KIT



14.3205006 Kit placca posteriore per uso palmare trasparente
Transparent mounting frame kit for handle use

PAG 22

RICAMBI / SPARE PARTS



PM10012017 Vite d 2,9 x 6,5 TS per la placca chiusura
Screw d 2,9 x 6,5 TS for closing plate itouch

PAG 22

PM10012018 Vite d 2,9 x 9,5 TS punta tronca per telaio
Screw d 2,9 x 9,5 TS truncated tip for frame

PAG 22

PM10012019 Vite d 2,9 x 19 TS tronca per telaio H25
Screw d 2,9 x 19 TS truncated tip for frame h25

PAG 22

ACCESSORI / ACCESSORIES

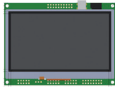

14.TFT4301 Display 4,3" senza pannello Touch con controllo elettronico
4,3" display without Touch panel with electronic control

PAG 39

FINISHING SERVICE

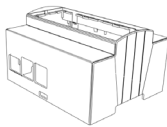

Finishing service

PAG 42

INDICE/INDEX

ANELLI CORNICE / FRAME RINGS



P14004305A Anelli cornice H10 - bianco
Frame rings H10 - white PAG 24



P14004105A Anelli cornice H10 - nero
Frame rings H10 - black PAG 24



P14004135A Anelli cornice H10 - cromo
Frame rings H10 - chrome PAG 24



P14005305A Anelli cornice H15 - bianco
Frame rings H15 - white PAG 24



P14005105A Anelli cornice H15 - nero
Frame rings H15 - black PAG 24



P14005135A Anelli cornice H15 - cromo
Frame rings H15 - chrome PAG 24



P14009305A Anelli cornice H25 - bianco
Frame rings H25 - white PAG 24



P14009105A Anelli cornice H25 - nero
Frame rings H25 - black PAG 24

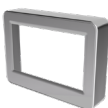

P14009135A Anelli cornice H25 - cromo
Frame rings H25 - chrome PAG 24

KIT CONTENITORE / ENCLOSURE KIT













14.3201310 Kit contenitore H10 - bianco
Enclosure kit H10 - white PAG 25



14.3201110 Kit contenitore H10 - nero
Enclosure kit H10 - black PAG 25

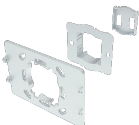
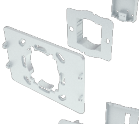
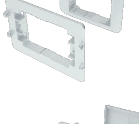

14.3201315 Kit contenitore H15 - bianco
Enclosure kit H15 - white PAG 25

	14.3201115	Kit contenitore H15 - nero Enclosure kit H15 - black	PAG 25
	14.3201325	Kit contenitore H25 - bianco Enclosure kit H25 - white	PAG 25
	14.3201125	Kit contenitore H25 - nero Enclosure kit H25 - black	PAG 25
KIT PLACCA POSTERIORE / MOUNTING FRAME KIT			
	14.3205001	Kit placca posteriore per scatola elettrica tipo 503 Mounting frame kit for electrical enclosure 503 / 3 gang	PAG 26
	14.3205002	Kit placca posteriore per scatola elettrica tipo D60 mm o 70x70 UK Mounting frame kit for electrical enclosure D60 type or 70x70 UK	PAG 26
	14.3205003	Kit placca posteriore per montaggio a parete o per scatola elettrica Mounting frame kit for wall mounting or for electrical enclosure	PAG 26
	14.3205011	Kit placca posteriore per scatola Ø60 H20 Mounting frame kit for Ø60 H20 box	PAG 27
	14.3205012	Kit placca posteriore per scatola Ø60 H20 KNX Mounting frame kit for Ø60 H20 box KNX	PAG 27
	14.3205021	Kit placca posteriore per scatola 503 H20 Mounting frame kit for 503 H20 box	PAG 27
	14.3205024	Kit placca posteriore per scatola 503 H20 KNX Mounting frame kit for 503 H20 box KNX	PAG 28
	14.3205004	Kit placca posteriore per uso palmare nero Black mounting frame kit for handle use	PAG 28
	14.3205005	Kit placca posteriore per uso palmare bianco White mounting frame kit for handle use	PAG 28
	14.3205006	Kit placca posteriore per uso palmare trasparente Transparent mounting frame kit for handle use	PAG 28

INDICE/INDEX

RICAMBI / SPARE PARTS



PM10012017 Vite d 2,9 x 6,5 TS per la placca chiusura
Screw d 2,9 x 6,5 TS for closing plate itouch PAG 28

PM10012018 Vite d 2,9 x 9,5 TS punta tronca per telaietto
Screw d 2,9 x 9,5 TS truncated tip for frame PAG 28

PM10012019 Vite d 2,9 x 19 TS tronca per telaio H25
Screw d 2,9 x 19 TS truncated tip for frame h25 PAG 28



P14000000G Guarnizione per anello STD Shape
iTouch STD Shape gasket PAG 29

ACCESSORI / ACCESSORIES

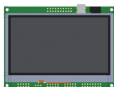

14.TFT4302 Display 4,3" con pannello Touch integrato controllo touch
4,3" display with Touch panel integrated electronic control PAG 39

ANELLI CORNICE / FRAME RINGS



P14001305A Anelli cornice H10
Frame rings H10 PAG 31



P14001105A Anelli cornice H10
Frame rings H10 PAG 31



P14001135A Anelli cornice H10
Frame rings H10 PAG 31



P14002305A Anelli cornice H15
Frame rings H15 PAG 31



P14002105A Anelli cornice H15
Frame rings H15 PAG 31



P14002135A Anelli cornice H15
Frame rings H15 PAG 31



P14003305A Anelli cornice H25
Frame rings H25 PAG 31



P14003105A Anelli cornice H25
Frame rings H25 PAG 31



P14003135A Anelli cornice H25
Frame rings H25 PAG 31

KIT CONTENITORE / ENCLOSURE KIT



14.3206310 Corpo contenitore H10 con base CSF - bianco
Body enclosure H10 with CSF base type - white PAG 32



14.3206110 Corpo contenitore H10 con base CSF - nero
Body enclosure H10 with CSF base type - black PAG 32



14.3206315 Corpo contenitore H15 con base CSF - bianco
Body enclosure H15 with CSF base type - white PAG 32

INDICE/INDEX



14.3206115 Corpo contenitore H15 con base CSF - nero
Body enclosure H15 with CSF base type - black

PAG 32



14.3206325 Corpo contenitore H25 con base CSF - bianco
Body enclosure H25 with CSF base type - white

PAG 32



14.3206125 Corpo contenitore H25 con base CSF - nero
Body enclosure H25 with CSF base type - black

PAG 32

TELAIO / FRAME



P14001305T Telaio H10/15 -bianco
Frame H10/15 - white

PAG 33



P14003305T Telaio H25 -bianco
Frame H25 - white

PAG 33

PANNELLI FRONTALI / FRONT PANELS



P14033700V Pannello in vetro frontale trasparente
Transparent glass front panel

PAG 33



P14023700V Pannello in vetro frontale fumè
Smoked glass front panel

PAG 33



P14013700V Pannello in vetro frontale specchio
Mirror glass front panel

PAG 33

PANNELLO CHIUSO / CLOSED PANEL



P14006305T Pannello chiuso CSF base H10 - bianco
Closed panel CSF base H10 - white

PAG 34



P14006105T Pannello chiuso CSF base H10 - nero
Closed panel CSF base H10 - black

PAG 34



P14005305T Pannello chiuso CSF base H15 - bianco
Closed panel CSF base H15 - white

PAG 34



P14005105T Pannello chiuso CSF base H15 - nero
Closed panel CSF base H15 - black

PAG 34

INDICE/INDEX

	P14002305T	Pannello chiuso CSF base H25 - bianco Closed panel CSF base H25 - white	PAG 34
	P14002105T	Pannello chiuso CSF base H25 - nero Closed panel CSF base H25 - black	PAG 34
	P140023749	Pannello plastico frontale chiuso - bianco Plastic front panel closed - white	PAG 35
	P140033749	Pannello plastico frontale chiuso - nero Plastic front panel closed - black	PAG 35
PANNELLO TOUCH RESISTIVO / TOUCH RESISTIVE PANEL			
	14.TP10000	Pannello touch resistivo frontale nero Black front touch resistive panel	PAG 35
	14.TP30000	Pannello touch resistivo frontale bianco White front touch resistive panel	PAG 35
	14.TP00000	Pannello touch resistivo frontale neutro Neutral front touch resistive panel	PAG 35
PANNELLO IN POLICARBONATO / POLYCARBONATE PANEL			
	P140013749	Pannello in policarbonato trasparente frontale Polycarbonate front transparent panel	PAG 35
MANOPOLE Ø20 / HANDLE Ø20			
			PAG 36
MANOPOLE Ø30 / HANDLE Ø30			
			PAG 36
KIT PERNI / PINS KIT			
	P14000001P	Kit perni PHIER Kit Phier pins	PAG 37
RICAMBI / SPARE PARTS			
	PM10012017	Vite d 2,9 x 6,5 TS per la placca chiusura Screw d 2,9 x 6,5 TS for closing plate itouch	PAG 37
	PM10012018	Vite d 2,9 x 9,5 TS punta tronca per telaio Screw d 2,9 x 9,5 TS truncated tip for frame	PAG 37
	PM10012019	Vite d 2,9 x 19 TS tronca per telaio H25 Screw d 2,9 x 19 TS truncated tip for frame h25	PAG 37



iShape

iTouch 80x120

Contenitore alloggiabile su scatola elettrica, per uso a parete o per uso palmare.

Materiale: ABS autoestinguente

Colore: Bianco (altri colori su richiesta)

CARATTERISTICHE

La linea iTouch soddisfa le esigenze del progettista elettronico che necessita di un contenitore elettronico dalle molteplici applicazioni a parete oppure per uso palmare. Infatti grazie alla giusta composizione dei kit offerti è possibile montare il dispositivo elettronico finale sulle scatole elettriche più comuni incassate nella parete oppure direttamente sulla parete liscia. E' possibile anche un uso palmare con estetica attuale.

Il contenitore iTouch è studiato per contenere elettronica a display con pannello Touch, oppure per il tradizionale impiego con pannelli piatti di vario tipo, anche in vetro. Il pannello Touch deve essere saldato sulla scheda elettronica.

iShape

iTouch 80x120

Enclosure to be assembled on electric case, for wall use or for handheld use.

Material: ABS self-extinguishing

Colour: White (other colours on request)

FEATURES

The iTouch range satisfies the exigencies of the electronic designer who needs an electronic enclosure with various wall or handheld applications. In fact, thanks to the right kit composition offered, it is possible to assemble the final electronic device on the most common electric cases inserted in the wall or directly on the flat wall. A handheld use with actual aesthetic is also possible.

The iTouch enclosure has been studied to contain display electronics with Touch panel or for the traditional use with flat panels of various types, even glass panels. The Touch panel must be soldered on the electronic card.

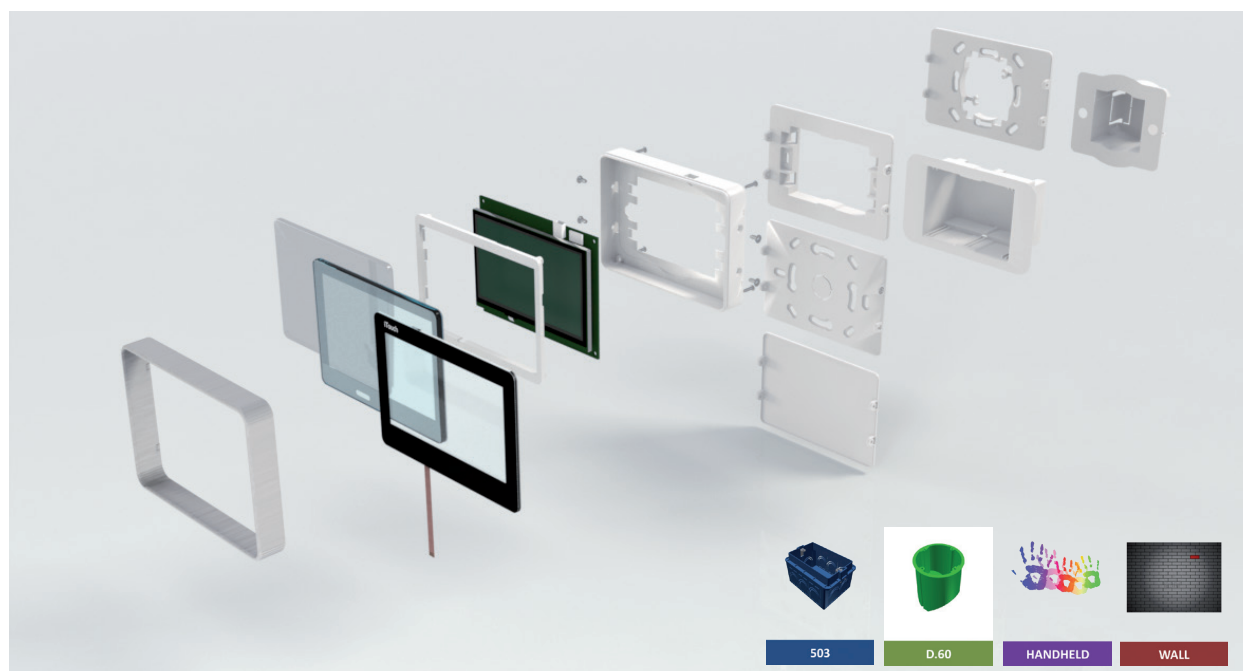

ANELLI CORNICE

CARATTERISTICHE GENERALI

Materiale: ABS autoestinguente

Colore: Bianco, nero, cromo e su richiesta

FRAME RING

GENERAL FEATURES

Material: ABS self-extinguishing

Colour: White, black, chrome and on request

ANELLI CORNICE H10



Bianco / White



Nero / Black



Cromo / Chrome

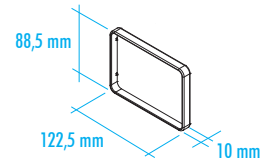

CODICE / CODE	COLORE / COLOUR	DESCRIZIONE/DESCRIPTION
P14001305A	Bianco / White	Anello cornice H10 / Frame ring H10
P14001105A	Nero / Black	Anello cornice H10 / Frame ring H10
P14001135A	Cromo / Chrome	Anello cornice H10 / Frame ring H10 *su richiesta / on request

CONFEZIONE N° PCS/KIT: 50

PACKAGING N° PCS/KIT: 50

PESO DELLA CONFEZIONE: 0,60 kg

PACKAGING WEIGHT: 0,60 kg

MINIMO ACQUISTABILE: 1

MINIMUM ORDER: 1

PESO DEL PEZZO KIT: 9 g

KIT WEIGHT: 9 g

ANELLI CORNICE H15



Bianco / White



Nero / Black



Cromo / Chrome

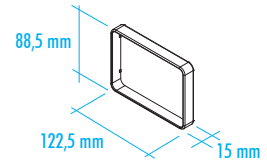

CODICE / CODE	COLORE / COLOUR	DESCRIZIONE/DESCRIPTION
P14002305A	Bianco / White	Anello cornice H15 / Frame ring H15
P14002105A	Nero / Black	Anello cornice H15 / Frame ring H15
P14002135A	Cromo / Chrome	Anello cornice H15 / Frame ring H15 *su richiesta / on request

CONFEZIONE N° PCS/KIT: 50

PACKAGING N° PCS/KIT: 50

PESO DELLA CONFEZIONE: 0,70 kg

PACKAGING WEIGHT: 0,70 kg

MINIMO ACQUISTABILE: 1

MINIMUM ORDER: 1

PESO DEL PEZZO KIT: 11 g

KIT WEIGHT: 11 g

ANELLI CORNICE H25



Bianco / White



Nero / Black



Cromo / Chrome

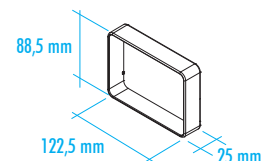

CODICE / CODE	COLORE / COLOUR	DESCRIZIONE/DESCRIPTION
P14003305A	Bianco / White	Anello cornice H25 / Frame ring H25
P14003105A	Nero / Black	Anello cornice H25 / Frame ring H25
P14003135A	Cromo / Chrome	Anello cornice H25 / Frame ring H25 *su richiesta / on request

CONFEZIONE N° PCS/KIT: 50

PACKAGING N° PCS/KIT: 50

PESO DELLA CONFEZIONE: 1 kg

PACKAGING WEIGHT: 1 kg

MINIMO ACQUISTABILE: 1

MINIMUM ORDER: 1

PESO DEL PEZZO KIT: 17 g

KIT WEIGHT: 17 g

NOTA: altri colori su richiesta:



NOTE: other colours on request:



PANNELLO IN VETRO**CARATTERISTICHE GENERALI**

Materiale: Vetro

Colore: Trasparente, Fumè, Specchio

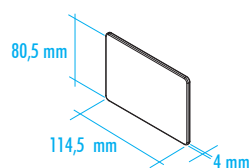
**GLASS PANEL****GENERAL FEATURES**

Material: Glass

Colour: Transparent, Smoked, Mirror



CODICE / CODE	COLORE / COLOUR	DESCRIZIONE/DESCRIPTION
P14033700V	Trasparente / Transparent	Pannello in vetro frontale / Glass front panel
P14023700V	Fumè / Smoked	Pannello in vetro frontale / Glass front panel
P14013700V	Specchio / Mirror	Pannello in vetro frontale / Glass front panel

NOTA: pannello e biadesivo.

NOTE: panel and double-side adhesive.

CONFEZIONE N° PCS/KIT:	25	MINIMO ACQUISTABILE:	1
PACKAGING N° PCS/KIT:	25	MINIMUM ORDER:	1
PESO DELLA CONFEZIONE:	2,35 kg	PESO DEL PEZZO KIT:	88 g
PACKAGING WEIGHT:	2,35 kg	KIT WEIGHT:	88 g

PANNELLO TOUCH RESISTIVO**CARATTERISTICHE GENERALI**

Colore: Bianco, nero e neutro

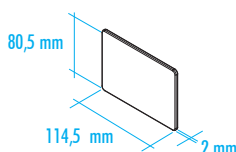
**TOUCH RESISTIVE PANEL****GENERAL FEATURES**

Colour: White, black and neutral



CODICE / CODE	COLORE / COLOUR	DESCRIZIONE/DESCRIPTION
14.TP10000	Nero / Black	Pannello touch resistivo frontale / Front touch resistive panel
14.TP30000	Bianco / White	Pannello touch resistivo frontale / Front touch resistive panel
14.TP00000	Neutro / Neutral	Pannello touch resistivo frontale / Front touch resistive panel

CONFEZIONE N° PCS/KIT:	25	MINIMO ACQUISTABILE:	1
PACKAGING N° PCS/KIT:	25	MINIMUM ORDER:	1
PESO DELLA CONFEZIONE:	0,65 kg	PESO DEL PEZZO KIT:	20 g
PACKAGING WEIGHT:	0,65 kg	KIT WEIGHT:	20 g

PANNELLO IN POLICARBONATO**CARATTERISTICHE GENERALI**

Materiale: Policarbonato

Colore: Neutro

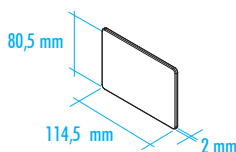
**POLYCARBONATE PANEL****GENERAL FEATURES**

Material: Polycarbonate

Colour: Neutral

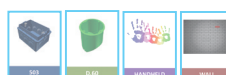

CODICE / CODE	COLORE / COLOUR	DESCRIZIONE/DESCRIPTION
P140013749	Neutro / Neutral	Pannello in policarbonato trasparente frontale / Polycarbonate front transparent panel *su richiesta /on request

NOTA: pannello e biadesivo.

NOTE: panel and double-side adhesive.

CONFEZIONE N° PCS/KIT:	25	MINIMO ACQUISTABILE:	1
PACKAGING N° PCS/KIT:	25	MINIMUM ORDER:	1
PESO DELLA CONFEZIONE:	0,70 kg	PESO DEL PEZZO KIT:	22 g
PACKAGING WEIGHT:	0,70 kg	KIT WEIGHT:	22 g

PANNELLO CHIUSO CARATTERISTICHE GENERALI

Colore: Bianco e nero

CLOSED PANEL GENERAL FEATURES

Colour: White and black

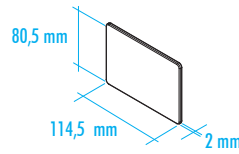

CODICE / CODE	COLORE / COLOUR	DESCRIZIONE/DESCRIPTION
P140023749	Bianco / White	Pannello plastico frontale chiuso / Plastic front panel closed
P140033749	Nero / Black	Pannello plastico frontale chiuso / Plastic front panel closed

NOTA: pannello e biadesivo.

NOTE: panel and double-side adhesive.

CONFEZIONE N° PCS/KIT:	25	MINIMO ACQUISTABILE:	1
PACKAGING N° PCS/KIT:	25	MINIMUM ORDER:	1
PESO DELLA CONFEZIONE:	0,83 kg	PESO DEL PEZZO KIT:	27 g
PACKAGING WEIGHT:	0,83 kg	KIT WEIGHT:	27 g

KIT CONTENITORE CARATTERISTICHE GENERALI

Materiale: ABS autoestinguente
Colore: Bianco e nero,

ENCLOSURE KIT GENERAL FEATURES

Material: ABS self-extinguishing
Colour: White and black

KIT CONTENITORE H10



Bianco / White



Nero / Black

ENCLOSURE KIT H10

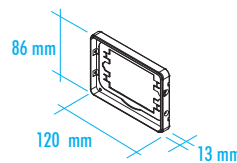

CODICE / CODE	COLORE / COLOUR	DESCRIZIONE/DESCRIPTION
14.3201310	Bianco / White	KIT contenitore H10 / Enclosure KIT H10
14.3201110	Nero / Black	KIT contenitore H10 / Enclosure KIT H10

CONFEZIONE N° PCS/KIT: 50	PESO DELLA CONFEZIONE: 1,65 kg	MINIMO ACQUISTABILE: 1	PESO DEL PEZZO KIT: 30 g
PACKAGING N° PCS/KIT: 50	PACKAGING WEIGHT: 1,65 kg	MINIMUM ORDER: 1	KIT WEIGHT: 30 g

KIT CONTENITORE H15



Bianco / White



Nero / Black

ENCLOSURE KIT H15

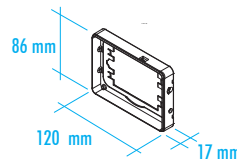

CODICE / CODE	COLORE / COLOUR	DESCRIZIONE/DESCRIPTION
14.3201315	Bianco / White	KIT contenitore H15 / Enclosure KIT H15
14.3201115	Nero / Black	KIT contenitore H15 / Enclosure KIT H15

CONFEZIONE N° PCS/KIT: 50	PESO DELLA CONFEZIONE: 1,90 kg	MINIMO ACQUISTABILE: 1	PESO DEL PEZZO KIT: 35 g
PACKAGING N° PCS/KIT: 50	PACKAGING WEIGHT: 1,90 kg	MINIMUM ORDER: 1	KIT WEIGHT: 35 g

NOTA: scegliere il corretto abbinamento con la cornice frontale.
Kit contenitore: Corpo contenitore iTouch, telaio porta display, n.8 viti.

NOTE: choose the correct matching with the front frame
Enclosure kit: Body case iTouch, display holder frame, 8 screws.



KIT CONTENITORE H25



Bianco / White



Nero / Black

ENCLOSURE KIT H25

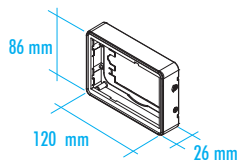

CODICE / CODE	COLORE / COLOUR	DESCRIZIONE/DESCRIPTION
14.3201325	Bianco / White	KIT contenitore H25 / Enclosure KIT H25
14.3201125	Nero / Black	KIT contenitore H25 / Enclosure KIT H25

CONFEZIONE N° PCS/KIT: 50
PACKAGING N° PCS/KIT: 50

PESO DELLA CONFEZIONE: 2,40 kg
PACKAGING WEIGHT: 2,40 kg

MINIMO ACQUISTABILE: 1
MINIMUM ORDER: 1

PESO DEL PEZZO KIT: 45 g
KIT WEIGHT: 45 g

NOTA: scegliere il corretto abbinamento con la cornice frontale.
Kit contenitore: Corpo contenitore iTouch, telaio porta display, n.8 viti.

NOTE: choose the correct matching with the front frame
Enclosure kit: Body case iTouch, display holder frame, 8 screws.

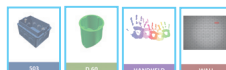

KIT CONTENITORE H10 CON INSERITORE CARD

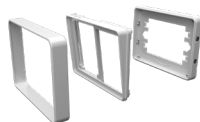

Bianco / White



Nero / Black

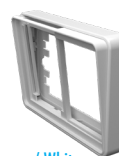
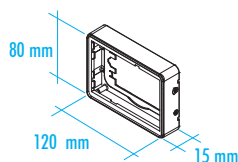

Bianco / White



Nero / Black

CODICE / CODE	COLORE / COLOUR	DESCRIZIONE/DESCRIPTION
14.3211310	Bianco / White	KIT contenitore H10 con inseritore card / Enclosure KIT H10 with card slot
14.3211110	Nero / Black	KIT contenitore H10 con inseritore card / Enclosure KIT H10 with card slot

CONFEZIONE N° PCS/KIT: 50
PACKAGING N° PCS/KIT: 50

PESO DELLA CONFEZIONE: 2,70 kg
PACKAGING WEIGHT: 2,70 kg

MINIMO ACQUISTABILE: 1
MINIMUM ORDER: 1

PESO DEL PEZZO KIT: 54 g
KIT WEIGHT: 54 g

NOTA: Corpo contenitore iTouch, telaio inseritore card, n°8 viti, cornice frontale.

NOTE: Body case iTouch, display holder frame, 8 screws, front frame.



KIT CONTENITORE CHIUSO H25

CARATTERISTICHE GENERALI

Materiale: ABS autoestinguente

Colore: Bianco e nero



Bianco / White



Nero / Black

CLOSED ENCLOSURE KIT H25

GENERAL FEATURES

Material: ABS self-extinguishing

Colour: White and black

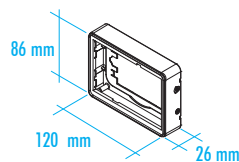

CODICE / CODE	COLORE / COLOUR	DESCRIZIONE/DESCRIPTION
14.3203325	Bianco / White	KIT contenitore H25 / Enclosure KIT H25
14.3203125	Nero / Black	KIT contenitore H25 / Enclosure KIT H25

CONFEZIONE N° PCS/KIT: 50
PACKAGING N° PCS/KIT: 50

PESO DELLA CONFEZIONE: 2,40 kg
PACKAGING WEIGHT: 2,40 kg

MINIMO ACQUISTABILE: 1
MINIMUM ORDER: 1

PESO DEL PEZZO KIT: 45 g
KIT WEIGHT: 45 g

NOTA: scegliere il corretto abbinamento con la cornice frontale.
Kit contenitore: Corpo contenitore iTouch, telaio con pannello chiuso, n.8 viti.

NOTE: choose the correct matching with the front frame
Enclosure kit: Body case iTouch, frame with closed panel, 8 screws.

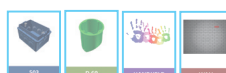

**KIT PLACCA POSTERIORE PER SCATOLA
ELETTRICA TIPO 503****CARATTERISTICHE GENERALI**

Materiale: ABS autoestinguente
Colore: Neutro

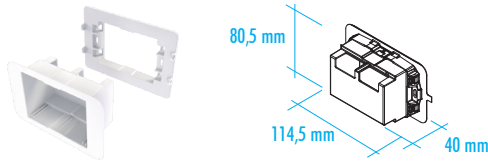

CODICE / CODE	COLORE / COLOUR	DESCRIZIONE/DESCRIPTION
14.3205001	Neutro / Neutral	KIT Placca posteriore per scatola 503 / KIT mounting frame for box 503

NOTA: contenitore 503, placca per 503

NOTE: 503 enclosure, 503 frame

CONFEZIONE N° PCS/KIT:	50
PACKAGING N° PCS/KIT:	50
PESO DELLA CONFEZIONE:	1,90 kg
PACKAGING WEIGHT:	1,90 kg

MINIMO ACQUISTABILE:	1
MINIMUM ORDER:	1
PESO DEL PEZZO KIT:	35 g
KIT WEIGHT:	35 g

**KIT PLACCA POSTERIORE PER SCATOLA
ELETTRICA TIPO D60 O 70X70 UK****CARATTERISTICHE GENERALI**

Materiale: ABS autoestinguente
Colore: Neutro

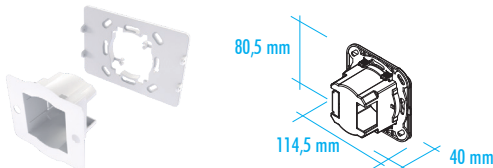

CODICE / CODE	COLORE / COLOUR	DESCRIZIONE/DESCRIPTION
14.3205002	Neutro / Neutral	KIT Placca posteriore per scatola Ø60 / KIT mounting frame for box Ø60

NOTA: contenitore Ø60, placca per Ø60

NOTE: Ø60 enclosure, Ø60 frame

CONFEZIONE N° PCS/KIT:	50
PACKAGING N° PCS/KIT:	50
PESO DELLA CONFEZIONE:	1,48 kg
PACKAGING WEIGHT:	1,48 kg

MINIMO ACQUISTABILE:	1
MINIMUM ORDER:	1
PESO DEL PEZZO KIT:	26,5 g
KIT WEIGHT:	26,5 g

**KIT PLACCA POSTERIORE PER MONTAGGIO
A PARETE O PER SCATOLA ELETTRICA****CARATTERISTICHE GENERALI**

Materiale: ABS autoestinguente
Colore: Neutro

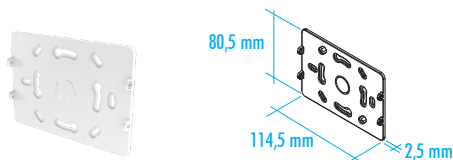

CODICE / CODE	COLORE / COLOUR	DESCRIZIONE/DESCRIPTION
14.3205003	Neutro / Neutral	Placca posteriore per uso piatto a parete / Mounting frame for wall mounting

CONFEZIONE N° PCS/KIT:	50
PACKAGING N° PCS/KIT:	50
PESO DELLA CONFEZIONE:	1,15 kg
PACKAGING WEIGHT:	1,15 kg

MINIMO ACQUISTABILE:	1
MINIMUM ORDER:	1
PESO DEL PEZZO KIT:	20 g
KIT WEIGHT:	20 g



KIT PLACCA POSTERIORE PER SCATOLA ELETTRICA TIPO Ø60 H20

CARATTERISTICHE GENERALI

Material: ABS autoestinguente

Colore: Bianco

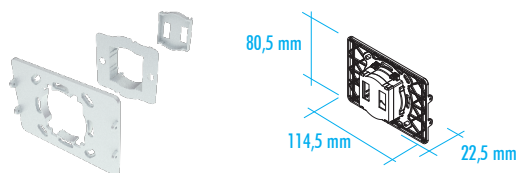

CODICE / CODE **COLORE / COLOUR** **DESCRIZIONE/DESCRIPTION**

14.3205011 Bianco / White KIT Placca posteriore per scatola Ø60 H20 / KIT mounting frame for box Ø60 H20

NOTA: cornice post. D60, corpo cont. D60 H20 e chiusura post. D60 H20

MOUNTING FRAME KIT FOR ELECTRICAL ENCLOSURE Ø60 H20

GENERAL FEATURES

Material: ABS self-extinguishing

Colour: White

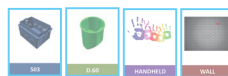

CONFEZIONE N° PCS/KIT:	50
PACKAGING N° PCS/KIT:	50
PESO DELLA CONFEZIONE:	1,65 kg
PACKAGING WEIGHT:	1,65 kg

MINIMO ACQUISTABILE:	1
MINIMUM ORDER:	1
PESO DEL PEZZO KIT:	30 g
KIT WEIGHT:	30 g

NOTE: Mounting frame D60, body enclosure D60 H20 and back cover D60 H20

KIT PLACCA POSTERIORE PER SCATOLA ELETTRICA TIPO Ø60 H20 KNX

CARATTERISTICHE GENERALI

Material: ABS autoestinguente

Colore: Bianco

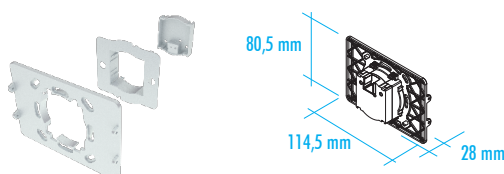

CODICE / CODE **COLORE / COLOUR** **DESCRIZIONE/DESCRIPTION**

14.3205012 Bianco / White KIT Placca posteriore per scatola Ø60 H20 KNX / KIT mounting frame for box Ø60 H20 KNX

NOTA: cornice post. D60, corpo cont. D60 H20 e chiusura post. D60 H20 KNX

MOUNTING FRAME KIT FOR ELECTRICAL D60 TYPE Ø60 H20 KNX

GENERAL FEATURES

Material: ABS self-extinguishing

Colour: White



CONFEZIONE N° PCS/KIT:	50
PACKAGING N° PCS/KIT:	50
PESO DELLA CONFEZIONE:	1,65 kg
PACKAGING WEIGHT:	1,65 kg

MINIMO ACQUISTABILE:	1
MINIMUM ORDER:	1
PESO DEL PEZZO KIT:	30 g
KIT WEIGHT:	30 g

NOTE: Mounting frame D60, body enclosure D60 H20 and back cover D60 H20 KNX

KIT PLACCA POSTERIORE PER SCATOLA ELETTRICA TIPO 503 H20

CARATTERISTICHE GENERALI

Material: ABS autoestinguente

Colore: Bianco

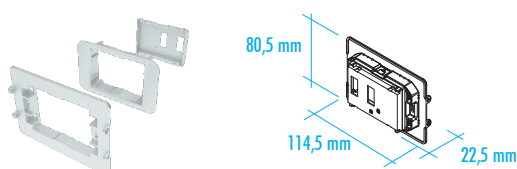

CODICE / CODE **COLORE / COLOUR** **DESCRIZIONE/DESCRIPTION**

14.3205021 Bianco / White KIT Placca posteriore per scatola 503 H20 / KIT mounting frame for box 503 H20

NOTA: cornice post. 503, corpo cont. 503 H20 e chiusura post. 503 H20

MOUNTING FRAME KIT FOR ELECTRICAL D60 TYPE 503 H20

GENERAL FEATURES

Material: ABS self-extinguishing

Colour: White

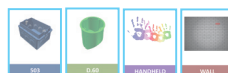

CONFEZIONE N° PCS/KIT:	50
PACKAGING N° PCS/KIT:	50
PESO DELLA CONFEZIONE:	1,90 kg
PACKAGING WEIGHT:	1,90 kg

MINIMO ACQUISTABILE:	1
MINIMUM ORDER:	1
PESO DEL PEZZO KIT:	35 g
KIT WEIGHT:	35 g

NOTE: Mounting frame 503, body enclosure 503 H20 and back cover 503 H20

KIT PLACCA POSTERIORE PER SCATOLA ELETTRICA TIPO 503 H20 KNX

CARATTERISTICHE GENERALI

Materiale: ABS autoestinguente
Colore: Bianco

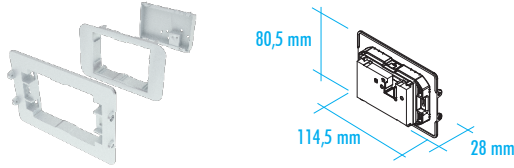

CODICE / CODE	COLORE / COLOUR	DESCRIZIONE/DESCRIPTION
14.3205024	Bianco / White	KIT Placca posteriore per scatola 503 H20 KNX / KIT mounting frame for box 503 H20 KNX

NOTA: cornice post. 503, corpo cont. 503 H20 e chiusura post. 503 H20 KNX

MOUNTING FRAME KIT FOR ELECTRICAL D60 TYPE 503 H20 KNX

GENERAL FEATURES

Material: ABS self-extinguishing
Colour: White



CONFEZIONE N° PCS/KIT:	50
PACKAGING N° PCS/KIT:	50
PESO DELLA CONFEZIONE:	1,90 kg
PACKAGING WEIGHT:	1,90 kg

MINIMO ACQUISTABILE:	1
MINIMUM ORDER:	1
PESO DEL PEZZO KIT:	35 g
KIT WEIGHT:	35 g

NOTE: Mounting frame 503, body enclosure 503 H20 and back cover 503 H20 KNX

PLACCA POSTERIORE PER USO PALMARE

CARATTERISTICHE GENERALI

Materiale: ABS autoestinguente
Colore: Nero, bianco e trasparente



Bianco / White

Nero / Black

Trasparente / Transparent

MOUNTING FRAME FOR HANDLE USE

GENERAL FEATURES

Material: ABS self-extinguishing
Colour: Black, white and transparent



CODICE / CODE	COLORE / COLOUR	DESCRIZIONE/DESCRIPTION
14.3205004	Nero / Black	Placca posteriore per uso palmare / Mounting frame for hand-held use
14.3205005	Bianco / White	Placca posteriore per uso palmare / Mounting frame for hand-held use
14.3205006	Trasparente / Transparent	Placca posteriore per uso palmare / Mounting frame for hand-held use

CONFEZIONE N° PCS/KIT:	50
PACKAGING N° PCS/KIT:	50
PESO DELLA CONFEZIONE:	0,80 kg
PACKAGING WEIGHT:	0,80 kg

MINIMO ACQUISTABILE:	1
MINIMUM ORDER:	1
PESO DEL PEZZO KIT:	13 g
KIT WEIGHT:	13 g

VITI

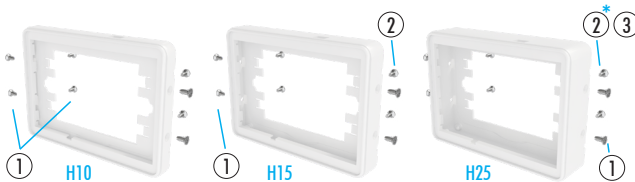

SCREWS

NOTA: prego usare la stessa vite per il telaio o per il pannello integrato.

NOTE: please use same screw for frame or panel integrated version.



CODICE / CODE	REF	COLORE / COLOUR	DESCRIZIONE/DESCRIPTION
PM10012017	①	Bianco zincata/Galvanized white	Vite d 2,9 x 6,5 TS / Screw d 2,9 x 6,5 TS
PM10012018	②	Bianco zincata/Galvanized white	Vite d 2,9 x 9,5 TS / Screw d 2,9 x 9,5 TS
PM10012019	③	Bianco zincata/Galvanized white	Vite d 2,9 x 19 TS / Screw d 2,9 x 19 TS

*SOLO VERSIONE CSF

*ONLY VERSION CSF

CONF./PACK N° PCS/KIT	① 1000	② 5000	③ 1000
PESO DELLA CONF./ PACK. WEIGHT	① 0,6 kg	② 2,6 kg	③ 1,0 kg

MIN. ACQUISTABILE/ MIN. ORDER	① 1	② 1	③ 1
PESO DEL PEZZO KIT/KIT WEIGHT	① 0,5 g	② 0,5 g	③ 1 g

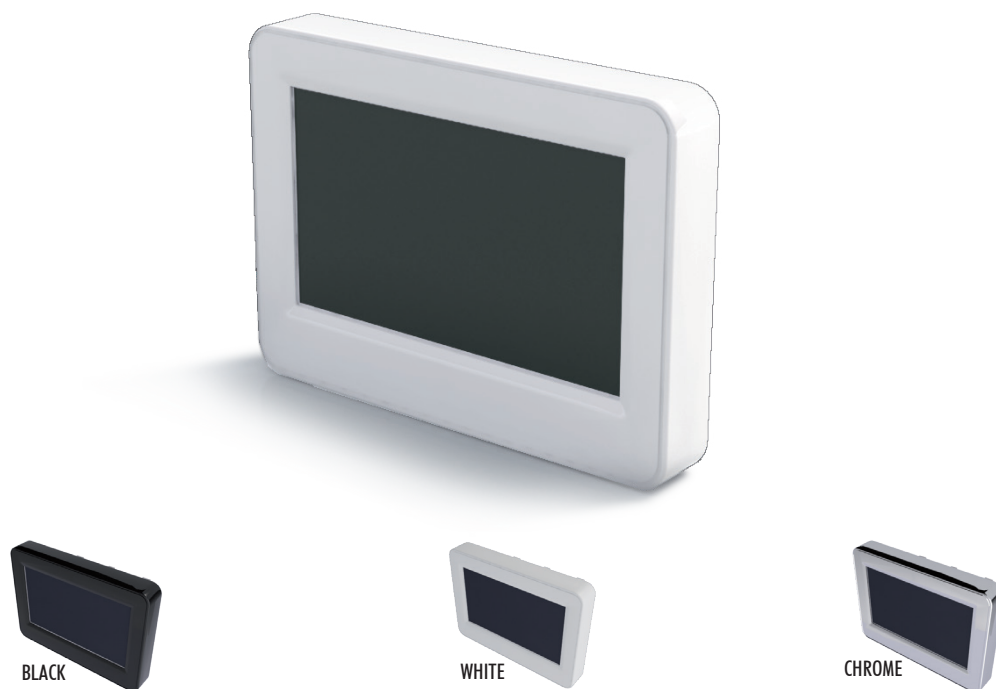

STD Shape

iTouch 80x120

Contenitore alloggiabile su scatola elettrica, per uso a parete o per uso palmare.

Materiale: ABS autoestinguente

Colore: Bianco (altri colori su richiesta)

CARATTERISTICHE

La linea iTouch soddisfa le esigenze del progettista elettronico che necessita di un contenitore elettronico dalle molteplici applicazioni a parete oppure per uso palmare. Infatti grazie alla giusta composizione dei kit offerti è possibile montare il dispositivo elettronico finale sulle scatole elettriche più comuni incassate nella parete oppure direttamente sulla parete liscia. E' possibile anche un uso palmare con estetica attuale.

Il contenitore iTouch è studiato per contenere elettronica a display con pannello Touch, oppure per il tradizionale impiego con pannelli piatti di vario tipo, anche in vetro. Il pannello Touch è già integrato sul display.

STD Shape

iTouch 80x120

Enclosure to be assembled on electric case, for wall use or for handheld use.

Material: ABS self-extinguishing

Colour: White (other colours on request)

FEATURES

The iTouch range satisfies the exigencies of the electronic designer who needs an electronic enclosure with various wall or handheld applications. In fact, thanks to the right kit composition offered, it is possible to assemble the final electronic device on the most common electric cases inserted in the wall or directly on the flat wall. A handheld use with actual aesthetic is also possible.

The iTouch enclosure has been studied to contain display electronics with Touch panel or for the traditional use with flat panels of various types, even glass panels. The Touch panel is already integrated on the display.

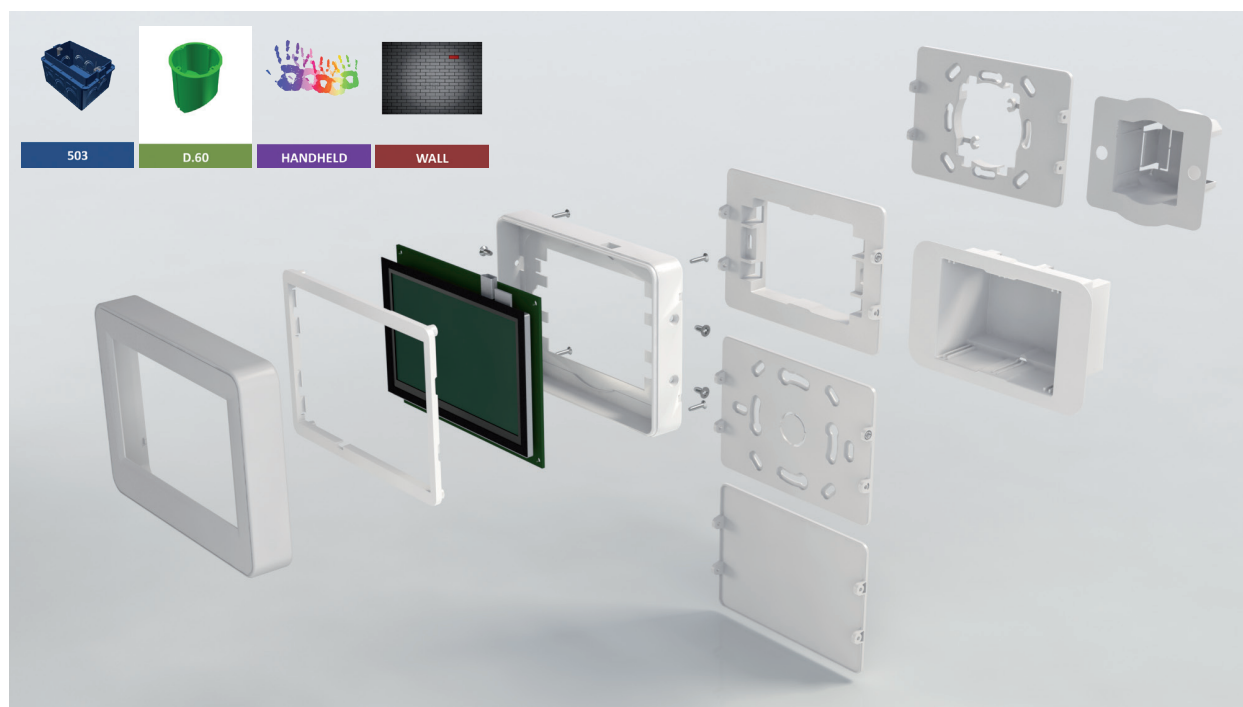

ANELLI CORNICE H10
CARATTERISTICHE GENERALI

Materiale: ABS autoestinguente
Colore: Bianco, nero, cromo e su richiesta

ANELLI CORNICE H10

Bianco / White



Nero / Black



Cromo / Chrome

CODICE / CODE	COLORE / COLOUR	DESCRIZIONE/DESCRIPTION
P14004305A	Bianco / White	Anello cornice H10 / Frame ring H10
P14004105A	Nero / Black	Anello cornice H10 / Frame ring H10
P14004135A	Cromo / Chrome	Anello cornice H10 / Frame ring H10

CONFEZIONE N° PCS/KIT: 50
PACKAGING N° PCS/KIT: 50

PESO DELLA CONFEZIONE: 0,85 kg
PACKAGING WEIGHT: 0,85 kg

MINIMO ACQUISTABILE: 1
MINIMUM ORDER: 1

PESO DEL PEZZO KIT: 14 g
KIT WEIGHT: 14 g

FRAME RING H10
GENERAL FEATURES

Material: ABS self-extinguishing
Colour: White, black, chrome and on request

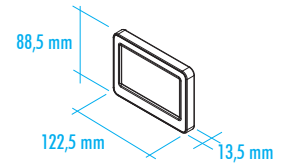
FRAME RING H10**ANELLI CORNICE H15**

Bianco / White



Nero / Black



Cromo / Chrome

CODICE / CODE	COLORE / COLOUR	DESCRIZIONE/DESCRIPTION
P14005305A	Bianco / White	Anello cornice H15 / Frame ring H15
P14005105A	Nero / Black	Anello cornice H15 / Frame ring H15
P14005135A	Cromo / Chrome	Anello cornice H15 / Frame ring H15

CONFEZIONE N° PCS/KIT: 50
PACKAGING N° PCS/KIT: 50

PESO DELLA CONFEZIONE: 1 kg
PACKAGING WEIGHT: 1 kg

MINIMO ACQUISTABILE: 1
MINIMUM ORDER: 1

PESO DEL PEZZO KIT: 17 g
KIT WEIGHT: 17 g

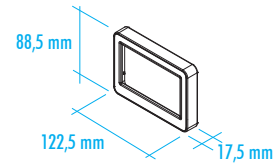
FRAME RING H15**ANELLI CORNICE H25**

Bianco / White



Nero / Black



Cromo / Chrome

CODICE / CODE	COLORE / COLOUR	DESCRIZIONE/DESCRIPTION
P14009305A	Bianco / White	Anello cornice H25 / Frame ring H25
P14009105A	Nero / Black	Anello cornice H25 / Frame ring H25
P14009135A	Cromo / Chrome	Anello cornice H25 / Frame ring H25

CONFEZIONE N° PCS/KIT: 50
PACKAGING N° PCS/KIT: 50

PESO DELLA CONFEZIONE: 1,43 kg
PACKAGING WEIGHT: 1,43 kg

MINIMO ACQUISTABILE: 1
MINIMUM ORDER: 1

PESO DEL PEZZO KIT: 25,5 g
KIT WEIGHT: 25,5 g

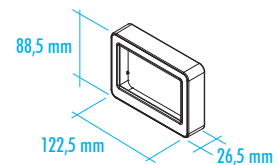
FRAME RING H25

NOTA: altri colori su richiesta:



NOTE: other colours on request:



KIT CONTENITORE CARATTERISTICHE GENERALI

Materiale: ABS autoestinguente
Colore: Bianco e nero

KIT CONTENITORE H10



ENCLOSURE KIT GENERAL FEATURES

Material: ABS self-extinguishing
Colour: White and black

ENCLOSURE KIT H10

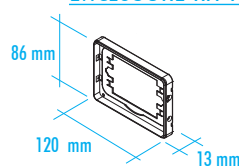

CODICE / CODE	COLORE / COLOUR	DESCRIZIONE/DESCRIPTION
14.3201310	Bianco / White	KIT contenitore H10 / Enclosure KIT H10
14.3201110	Nero / Black	KIT contenitore H10 / Enclosure KIT H10

CONFEZIONE N° PCS/KIT: 50
PACKAGING N° PCS/KIT: 50

PESO DELLA CONFEZIONE: 1,65 kg
PACKAGING WEIGHT: 1,65 kg

MINIMO ACQUISTABILE: 1
MINIMUM ORDER: 1

PESO DEL PEZZO KIT: 30 g
KIT WEIGHT: 30 g

KIT CONTENITORE H15



ENCLOSURE KIT H15

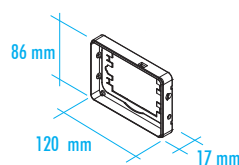

CODICE / CODE	COLORE / COLOUR	DESCRIZIONE/DESCRIPTION
14.3201315	Bianco / White	KIT contenitore H15 / Enclosure KIT H15
14.3201115	Nero / Black	KIT contenitore H15 / Enclosure KIT H15

CONFEZIONE N° PCS/KIT: 50
PACKAGING N° PCS/KIT: 50

PESO DELLA CONFEZIONE: 1,90 kg
PACKAGING WEIGHT: 1,90 kg

MINIMO ACQUISTABILE: 1
MINIMUM ORDER: 1

PESO DEL PEZZO KIT: 35 g
KIT WEIGHT: 35 g

NOTA: scegliere il corretto abbinamento con la cornice frontale.
Kit contenitore: Corpo contenitore iTouch, telaio porta display, n.8 viti.

NOTE: choose the correct matching with the front frame
Enclosure kit: Body case iTouch, display holder frame, 8 screws.

KIT CONTENITORE H25



ENCLOSURE KIT H25

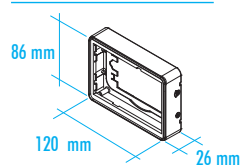

CODICE / CODE	COLORE / COLOUR	DESCRIZIONE/DESCRIPTION
14.3201325	Bianco / White	KIT contenitore H25 / Enclosure KIT H25
14.3201125	Nero / Black	KIT contenitore H25 / Enclosure KIT H25

CONFEZIONE N° PCS/KIT: 50
PACKAGING N° PCS/KIT: 50

PESO DELLA CONFEZIONE: 2,40 kg
PACKAGING WEIGHT: 2,40 kg

MINIMO ACQUISTABILE: 1
MINIMUM ORDER: 1

PESO DEL PEZZO KIT: 45 g
KIT WEIGHT: 45 g

NOTA: scegliere il corretto abbinamento con la cornice frontale.
Kit contenitore: Corpo contenitore iTouch, telaio porta display, n.8 viti.

NOTE: choose the correct matching with the front frame
Enclosure kit: Body case iTouch, display holder frame, 8 screws.

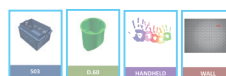

**KIT PLACCA POSTERIORE PER SCATOLA
ELETTRICA TIPO 503****CARATTERISTICHE GENERALI**

Materiale: ABS autoestinguente
Colore: Neutro

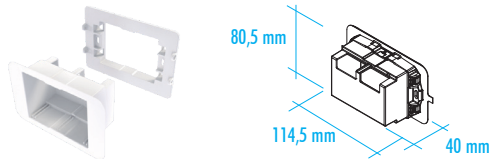

CODICE / CODE	COLORE / COLOUR	DESCRIZIONE/DESCRIPTION
14.3205001	Neutro / Neutral	KIT Placca posteriore per scatola 503 / KIT mounting frame for box 503

NOTA: contenitore 503, placca per 503

**MOUNTING FRAME KIT FOR ELECTRICAL
ENCLOSURE 503/3 GANG****GENERAL FEATURES**

Material: ABS self-extinguishing
Colour: Neutral



NOTE: 503 enclosure, 503 frame

CONFEZIONE N° PCS/KIT:	50
PACKAGING N° PCS/KIT:	50
PESO DELLA CONFEZIONE:	1,90 kg
PACKAGING WEIGHT:	1,90 kg

MINIMO ACQUISTABILE:	1
MINIMUM ORDER:	1
PESO DEL PEZZO KIT:	35 g
KIT WEIGHT:	35 g

**KIT PLACCA POSTERIORE SU SCATOLA
ELETTRICA TIPO D60 O 70X70 UK****CARATTERISTICHE GENERALI**

Materiale: ABS autoestinguente
Colore: Neutro

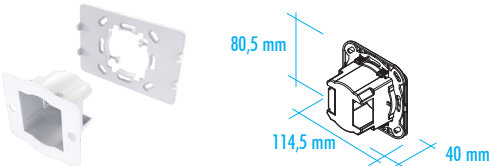

CODICE / CODE	COLORE / COLOUR	DESCRIZIONE/DESCRIPTION
14.3205002	Neutro / Neutral	KIT Placca posteriore per scatola Ø60 / KIT mounting frame for box Ø60

NOTA: contenitore Ø60, placca per Ø60

**MOUNTING FRAME KIT FOR ELECTRICAL
ENCLOSURE D60 TYPE OR 70X70 UK****GENERAL FEATURES**

Material: ABS self-extinguishing
Colour: Neutral



NOTE: Ø60 enclosure, Ø60 frame

CONFEZIONE N° PCS/KIT:	50
PACKAGING N° PCS/KIT:	50
PESO DELLA CONFEZIONE:	1,48 kg
PACKAGING WEIGHT:	1,48 kg

MINIMO ACQUISTABILE:	1
MINIMUM ORDER:	1
PESO DEL PEZZO KIT:	26,5 g
KIT WEIGHT:	26,5 g

**PLACCA POSTERIORE PER MONTAGGIO A
PARETE O PER SCATOLA ELETTRICA****CARATTERISTICHE GENERALI**

Materiale: ABS autoestinguente
Colore: Neutro

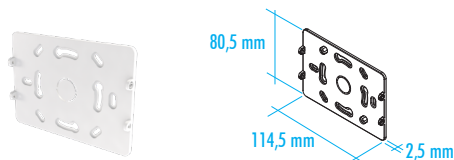

CODICE / CODE	COLORE / COLOUR	DESCRIZIONE/DESCRIPTION
14.3205003	Neutro / Neutral	Placca posteriore per uso piatto a parete / Mounting frame for wall mounting

**MOUNTING FRAME FOR WALL MOUNTING
OR FOR ELECTRICAL ENCLOSURE****GENERAL FEATURES**

Material: ABS self-extinguishing
Colour: Neutral



CONFEZIONE N° PCS/KIT:	50
PACKAGING N° PCS/KIT:	50
PESO DELLA CONFEZIONE:	1,15 kg
PACKAGING WEIGHT:	1,15 kg

MINIMO ACQUISTABILE:	1
MINIMUM ORDER:	1
PESO DEL PEZZO KIT:	20 g
KIT WEIGHT:	20 g

KIT PLACCA POSTERIORE PER SCATOLA ELETTRICA TIPO Ø60 H20

CARATTERISTICHE GENERALI

Material: ABS autoestinguente

Colore: Bianco

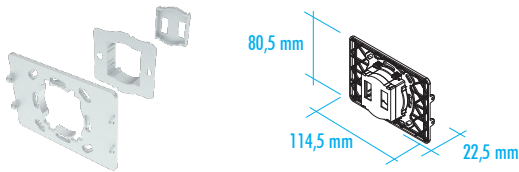

CODICE / CODE **COLORE / COLOUR** **DESCRIZIONE/DESCRIPTION**

14.3205011 Bianco / White KIT Placca posteriore per scatola Ø60 H20 / KIT mounting frame for box Ø60 H20

NOTA: cornice post. D60, corpo cont. D60 H20 e chiusura post. D60 H20

MOUNTING FRAME KIT FOR ELECTRICAL ENCLOSURE Ø60 H20

GENERAL FEATURES

Material: ABS self-extinguishing

Colour: White



CONFEZIONE N° PCS/KIT:	50
PACKAGING N° PCS/KIT:	50
PESO DELLA CONFEZIONE:	1,65 kg
PACKAGING WEIGHT:	1,65 kg

MINIMO ACQUISTABILE:	1
MINIMUM ORDER:	1
PESO DEL PEZZO KIT:	30 g
KIT WEIGHT:	30 g

NOTE: Mounting frame D60, body enclosure D60 H20 and back cover D60 H20

KIT PLACCA POSTERIORE PER SCATOLA ELETTRICA TIPO Ø60 H20 KNX

CARATTERISTICHE GENERALI

Material: ABS autoestinguente

Colore: Bianco

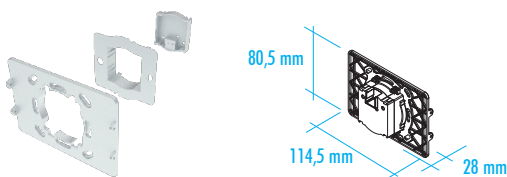

CODICE / CODE **COLORE / COLOUR** **DESCRIZIONE/DESCRIPTION**

14.3205012 Bianco / White KIT Placca posteriore per scatola Ø60 H20 KNX / KIT mounting frame for box Ø60 H20 KNX

NOTA: cornice post. D60, corpo cont. D60 H20 e chiusura post. D60 H20 KNX

MOUNTING FRAME KIT FOR ELECTRICAL D60 TYPE Ø60 H20 KNX

GENERAL FEATURES

Material: ABS self-extinguishing

Colour: White



CONFEZIONE N° PCS/KIT:	50
PACKAGING N° PCS/KIT:	50
PESO DELLA CONFEZIONE:	1,65 kg
PACKAGING WEIGHT:	1,65 kg

MINIMO ACQUISTABILE:	1
MINIMUM ORDER:	1
PESO DEL PEZZO KIT:	30 g
KIT WEIGHT:	30 g

NOTE: Mounting frame D60, body enclosure D60 H20 and back cover D60 H20 KNX

KIT PLACCA POSTERIORE PER SCATOLA ELETTRICA TIPO 503 H20

CARATTERISTICHE GENERALI

Material: ABS autoestinguente

Colore: Bianco

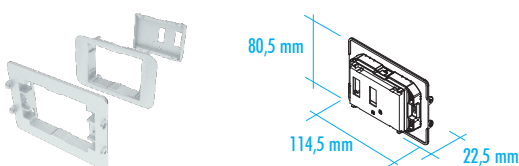

CODICE / CODE **COLORE / COLOUR** **DESCRIZIONE/DESCRIPTION**

14.3205021 Bianco / White KIT Placca posteriore per scatola 503 H20 / KIT mounting frame for box 503 H20

NOTA: cornice post. 503, corpo cont. 503 H20 e chiusura post. 503 H20

MOUNTING FRAME KIT FOR ELECTRICAL D60 TYPE 503 H20

GENERAL FEATURES

Material: ABS self-extinguishing

Colour: White



CONFEZIONE N° PCS/KIT:	50
PACKAGING N° PCS/KIT:	50
PESO DELLA CONFEZIONE:	1,90 kg
PACKAGING WEIGHT:	1,90 kg

MINIMO ACQUISTABILE:	1
MINIMUM ORDER:	1
PESO DEL PEZZO KIT:	35 g
KIT WEIGHT:	35 g

NOTE: Mounting frame 503, body enclosure 503 H20 and back cover 503 H20

KIT PLACCA POSTERIORE PER SCATOLA ELETTRICA TIPO 503 H20 KNX

CARATTERISTICHE GENERALI

Materiale: ABS autoestinguente
Colore: Bianco

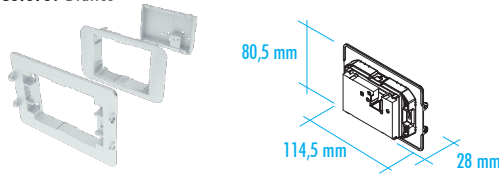

CODICE / CODE	COLORE / COLOUR	DESCRIZIONE/DESCRIPTION
14.3205024	Bianco / White	KIT Placca posteriore per scatola 503 H20 KNX / KIT mounting frame for box 503 H20 KNX

NOTA: cornice post. 503, corpo cont. 503 H20 e chiusura post. 503 H20 KNX

MOUNTING FRAME KIT FOR ELECTRICAL D60 TYPE 503 H20 KNX

GENERAL FEATURES

Material: ABS self-extinguishing
Colour: White



NOTE: Mounting frame 503, body enclosure 503 H20 and back cover 503 H20 KNX

CONFEZIONE N° PCS/KIT:	50	MINIMO ACQUISTABILE: 1	MINIMUM ORDER: 1
PACKAGING N° PCS/KIT:	50	PESO DEL PEZZO KIT: 35 g	KIT WEIGHT: 35 g
PESO DELLA CONFEZIONE:	1,90 kg		
PACKAGING WEIGHT:	1,90 kg		

PLACCA POSTERIORE PER USO PALMARE

CARATTERISTICHE GENERALI

Materiale: ABS autoestinguente

Colore: Nero, bianco e trasparente



Bianco / White

Nero / Black

Trasparente / Transparent

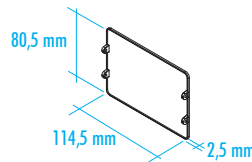

MOUNTING FRAME FOR HANDLE USE

GENERAL FEATURES

Material: ABS self-extinguishing

Colour: Black, white and transparent



CODICE / CODE	COLORE / COLOUR	DESCRIZIONE/DESCRIPTION
14.3205004	Nero / Black	Placca posteriore per uso palmare / Mounting frame for hand-held use
14.3205005	Bianco / White	Placca posteriore per uso palmare / Mounting frame for hand-held use
14.3205006	Trasparente / Transparent	Placca posteriore per uso palmare / Mounting frame for hand-held use

CONFEZIONE N° PCS/KIT:	50	MINIMO ACQUISTABILE: 1	MINIMUM ORDER: 1
PACKAGING N° PCS/KIT:	50	PESO DEL PEZZO KIT: 13 g	KIT WEIGHT: 13 g
PESO DELLA CONFEZIONE:	0,80 kg		
PACKAGING WEIGHT:	0,80 kg		

VITI

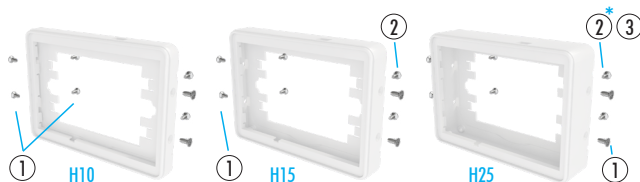

SCREWS

NOTA: prego usare la stessa vite per il telaio o per il pannello integrato.

NOTE: please use same screw for frame or panel integrated version.



CODICE / CODE	REF	COLORE / COLOUR	DESCRIZIONE/DESCRIPTION
PM10012017	①	Bianco zincata/Galvanized white	Vite d 2,9 x 6,5 TS / Screw d 2,9 x 6,5 TS
PM10012018	②	Bianco zincata/Galvanized white	Vite d 2,9 x 9,5 TS / Screw d 2,9 x 9,5 TS
PM10012019	③	Bianco zincata/Galvanized white	Vite d 2,9 x 19 TS / Screw d 2,9 x 19 TS

*SOLO VERSIONE CSF

*ONLY VERSION CSF

CONF./PACK N° PCS/KIT	MIN. ACQUISTABILE/ MIN. ORDER
① 1000 ② 5000 ③ 1000	① 1 ② 1 ③ 1
PESO DELLA CONF./ PACK. WEIGHT	PESO DEL PEZZO KIT/KIT WEIGHT
① 0,6 kg ② 2,6 kg ③ 1,0 kg	① 0,5 g ② 0,5 g ③ 1 g

GUARNIZIONE**CARATTERISTICHE GENERALI**

Materiale: Poron

Colore: Nero

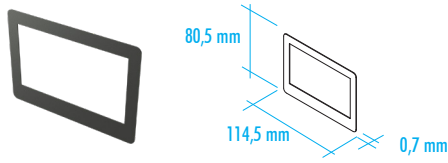
**GASKET****GENERAL FEATURES**

Material: Poron

Colour: Black

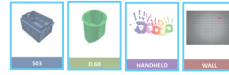

CODICE / CODE	COLORE / COLOUR	DESCRIZIONE / DESCRIPTION
P14000000G	Nero	Guarnizione per anello STD Shape/ iTouch STD Shape gasket

CONFEZIONE N° PCS/KIT:	50
PACKAGING N° PCS/KIT:	50
PESO DELLA CONFEZIONE:	0,4 kg
PACKAGING WEIGHT:	0,4 kg

MINIMO ACQUISTABILE:	1
MINIMUM ORDER:	1
PESO DEL PEZZO KIT:	5 g
KIT WEIGHT:	5 g

Solo per profondità 25mm/ Only
25mm thickness



BLACK



WHITE



BLACK CHROME



WHITE CHROME

CSF

iTouch 80x120

Contenitore per uso a parete

Materiale: ABS autoestinguente

Colore: Bianco (altri colori su richiesta)

CARATTERISTICHE

Il contenitore versione CSF della linea iTouch soddisfa le esigenze del progettista elettronico che necessita di un contenitore per elettronica da parete con sistema di conversione rapido: il sistema CSF prevede il cablaggio dei cavi sui morsetti con vite alloggiati sulla base del contenitore iTouch, a sua volta avvitata sulla parete; di seguito l'equipaggiamento elettronico è connesso semplicemente, grazie agli appositi pins diritti saldati nella scheda elettronica e sporgente nella parte posteriore, inserendolo nella femmina CSF già cablata e fissata a parete.

Il kit iTouch CSF è disponibile solo in versione 25 mm speciale con pannello chiuso in colore coordinato con la scatola e gli accessori, come le manopole. A richiesta disponibili versioni speciali con pannello trasparente o touch resistivo.

CSF

iTouch 80x120

Enclosure for wall use

MATERIAL: ABS self-extinguishing

Colour: White (other colours on request)

FEATURES

The enclosure CSF version of iTouch range satisfies the exigencies of the electronic designer who needs an electronic enclosure for wall mounting with rapid conversion system: CSF system provides the wiring of the cables on the terminals with screw located on the base of the iTouch case, which is screwed to the wall; then the electronic equipment is simply connected thanks to the special straight pins welded on the electronic card and protruding in the rear part, inserting it in the female CSF wired and fixed to the wall.

The kit iTouch CSF is available only in the version 25mm special with closed panel in colour-matching with the enclosure and the accessories, like the knobs. Available on request special versions with transparent panel or touch resistive.

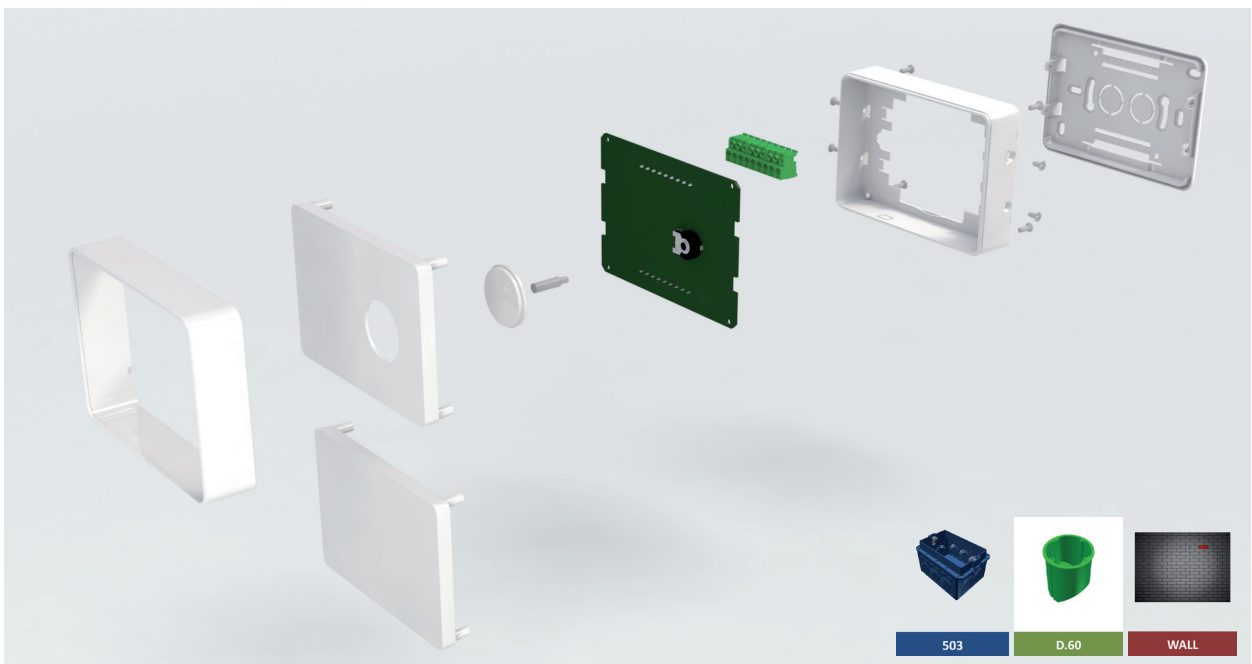

ANELLI CORNICE**CARATTERISTICHE GENERALI****Materiale:** ABS autoestinguente**Colore:** Bianco, nero, cromo e su richiesta**FRAME RING****GENERAL FEATURES****Material:** ABS self-extinguishing**Colour:** White, black, chrome and on request**ANELLI CORNICE H10**

Bianco / White



Nero / Black

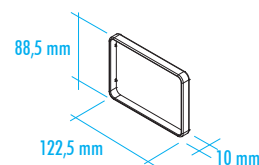

Cromo / Chrome

**CODICE / CODE COLORE / COLOUR DESCRIZIONE/DESCRIPTION**

P14001305A	Bianco / White	Anello cornice H10 / Frame ring H10
P14001105A	Nero / Black	Anello cornice H10 / Frame ring H10
P14001135A	Cromo / Chrome	Anello cornice H10 / Frame ring H10 *su richiesta / on request

CONFEZIONE N° PCS/KIT: 50
PACKAGING N° PCS/KIT: 50**PESO DELLA CONFEZIONE: 0,60 kg**
PACKAGING WEIGHT: 0,60 kg**MINIMO ACQUISTABILE: 1**
MINIMUM ORDER: 1**PESO DEL PEZZO KIT: 9 g**
KIT WEIGHT: 9 g**ANELLI CORNICE H15**

Bianco / White



Nero / Black

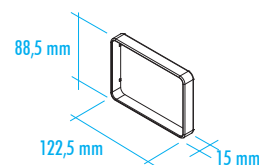

Cromo / Chrome

**CODICE / CODE COLORE / COLOUR DESCRIZIONE/DESCRIPTION**

P14002305A	Bianco / White	Anello cornice H15 / Frame ring H15
P14002105A	Nero / Black	Anello cornice H15 / Frame ring H15
P14002135A	Cromo / Chrome	Anello cornice H15 / Frame ring H15 *su richiesta / on request

CONFEZIONE N° PCS/KIT: 50
PACKAGING N° PCS/KIT: 50**PESO DELLA CONFEZIONE: 0,70 kg**
PACKAGING WEIGHT: 0,70 kg**MINIMO ACQUISTABILE: 1**
MINIMUM ORDER: 1**PESO DEL PEZZO KIT: 11 g**
KIT WEIGHT: 11 g**ANELLI CORNICE H25**

Bianco / White



Nero / Black

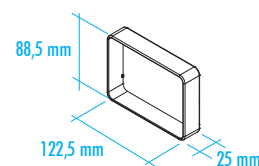

Cromo / Chrome

**CODICE / CODE COLORE / COLOUR DESCRIZIONE/DESCRIPTION**

P14003305A	Bianco / White	Anello cornice H25 / Frame ring H25
P14003105A	Nero / Black	Anello cornice H25 / Frame ring H25
P14003135A	Cromo / Chrome	Anello cornice H25 / Frame ring H25 *su richiesta / on request

CONFEZIONE N° PCS/KIT: 50
PACKAGING N° PCS/KIT: 50**PESO DELLA CONFEZIONE: 1 kg**
PACKAGING WEIGHT: 1 kg**MINIMO ACQUISTABILE: 1**
MINIMUM ORDER: 1**PESO DEL PEZZO KIT: 17 g**
KIT WEIGHT: 17 g

NOTA: altri colori su richiesta:



NOTE: other colours on request:

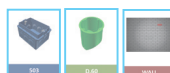

KIT CONTENITORE

CARATTERISTICHE GENERALI

Materiale: ABS autoestinguente
Colore: Bianco e nero

KIT CONTENITORE H10

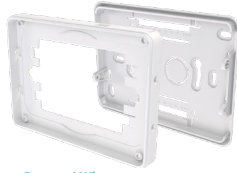

Bianco / White



Nero / Black

ENCLOSURE KIT

GENERAL FEATURES

Material: ABS self-extinguishing
Colour: White and black

ENCLOSURE KIT H10

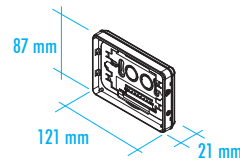

CODICE / CODE	COLORE / COLOUR	DESCRIZIONE/DESCRIPTION
14.3206310	Bianco / White	Corpo contenitore H10 con base CSF/ Body enclosure H10 with CSF base type
14.3206110	Nero / Black	Corpo contenitore H10 con base CSF/ Body enclosure H10 with CSF base type

CONFEZIONE N° PCS/KIT: 50
PACKAGING N° PCS/KIT: 50

PESO DELLA CONFEZIONE: 2,48 kg
PACKAGING WEIGHT: 2,48 kg

MINIMO ACQUISTABILE: 1
MINIMUM ORDER: 1

PESO DEL PEZZO KIT: 46,5 g
KIT WEIGHT: 46,5 g

KIT CONTENITORE H15

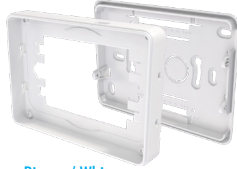

Bianco / White



Nero / Black

ENCLOSURE KIT H15

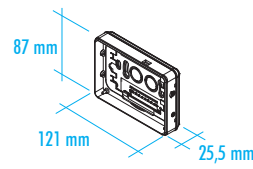

CODICE / CODE	COLORE / COLOUR	DESCRIZIONE/DESCRIPTION
14.3206315	Bianco / White	Corpo contenitore H15 con base CSF/ Body enclosure H15 with CSF base type
14.3206115	Nero / Black	Corpo contenitore H15 con base CSF/ Body enclosure H15 with CSF base type

CONFEZIONE N° PCS/KIT: 50
PACKAGING N° PCS/KIT: 50

PESO DELLA CONFEZIONE: 2,75kg
PACKAGING WEIGHT: 2,75 kg

MINIMO ACQUISTABILE: 1
MINIMUM ORDER: 1

PESO DEL PEZZO KIT: 52 g
KIT WEIGHT: 52 g

KIT CONTENITORE H25

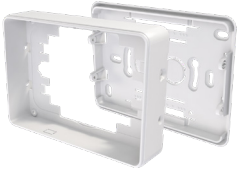

Bianco / White



Nero / Black

ENCLOSURE KIT H25

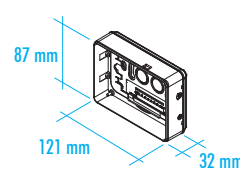

CODICE / CODE	COLORE / COLOUR	DESCRIZIONE/DESCRIPTION
14.3206325	Bianco / White	Corpo contenitore H25 con base CSF/ Body enclosure H25 with CSF base type
14.3206125	Nero / Black	Corpo contenitore H25 con base CSF/ Body enclosure H25 with CSF base type

CONFEZIONE N° PCS/KIT: 50
PACKAGING N° PCS/KIT: 50

PESO DELLA CONFEZIONE: 3,28 kg
PACKAGING WEIGHT: 3,28 kg

MINIMO ACQUISTABILE: 1
MINIMUM ORDER: 1

PESO DEL PEZZO KIT: 62,5 g
KIT WEIGHT: 62,5 g

NOTA: Corpo contenitore iTouch, placca posteriore CSF, n.8 viti.

NOTE: Body case iTouch, CSF mounting frame, 8 screws.

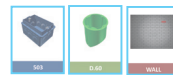

TELAIO**CARATTERISTICHE GENERALI**

Materiale: ABS autoestinguente

Colore: Bianco

FRAME**GENERAL FEATURES**

Material: ABS self-extinguishing

Colour: White

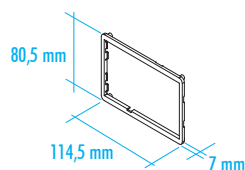
TELAIO H10/H15**FRAME H10/H15**

CODICE / CODE	COLORE / COLOUR	DESCRIZIONE/DESCRIPTION
P14001305T	Bianco / White	Telaio H10/15 / Frame H10/15

CONFEZIONE N° PCS/KIT: 25
PACKAGING N° PCS/KIT: 25

PESO DELLA CONFEZIONE: 0,25 kg
PACKAGING WEIGHT: 0,25 kg

MINIMO ACQUISTABILE: 1
MINIMUM ORDER: 1

PESO DEL PEZZO KIT: 4 g
KIT WEIGHT: 4 g

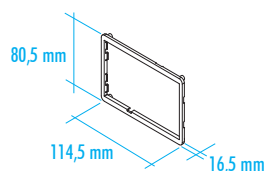
TELAIO H25**FRAME H25**

CODICE / CODE	COLORE / COLOUR	DESCRIZIONE/DESCRIPTION
P14003305T	Bianco / White	Telaio H25 con torretta 2mm / Frame H25 with turret 2mm

CONFEZIONE N° PCS/KIT: 25
PACKAGING N° PCS/KIT: 25

PESO DELLA CONFEZIONE: 0,30kg
PACKAGING WEIGHT: 0,30 kg

MINIMO ACQUISTABILE: 1
MINIMUM ORDER: 1

PESO DEL PEZZO KIT: 6 g
KIT WEIGHT: 6 g

TELAIO / FRAME

**PANNELLO IN VETRO****CARATTERISTICHE GENERALI**

Materiale: Vetro

Colore: Trasparente, Fumè, Specchio

GLASS PANEL**GENERAL FEATURES**

Material: Glass

Colour: Transparent, Smoked, Mirror

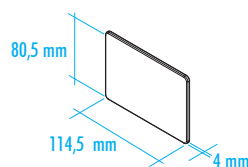

CODICE / CODE	COLORE / COLOUR	DESCRIZIONE/DESCRIPTION
P14033700V	Trasparente / Transparent	Pannello in vetro frontale / Glass front panel
P14023700V	Fumè / Smoked	Pannello in vetro frontale / Glass front panel
P14013700V	Specchio / Mirror	Pannello in vetro frontale / Glass front panel

NOTA: pannello e biadesivo.

NOTE: panel and double-side adhesive.

CONFEZIONE N° PCS/KIT: 25
PACKAGING N° PCS/KIT: 25

PESO DELLA CONFEZIONE: 2,35 kg
PACKAGING WEIGHT: 2,35 kg

MINIMO ACQUISTABILE: 1
MINIMUM ORDER: 1

PESO DEL PEZZO KIT: 88 g
KIT WEIGHT: 88 g

PANNELLI / PANELS

PANNELLO CHIUSO

CARATTERISTICHE GENERALI

Materiale: ABS autoestinguente
Colore: Bianco e nero

CLOSED PANEL

GENERAL FEATURES

Material: ABS self-extinguishing
Colour: White and black

PANNELLO CHIUSO H10



Bianco / White



Nero / Black

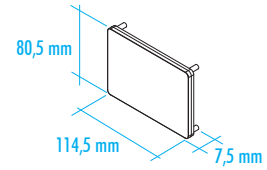

CODICE / CODE	COLORE / COLOUR	DESCRIZIONE/DESCRIPTION
P14006305T	Bianco / White	Pannello chiuso CSF base H10 / Closed panel CSF base H10
P14006105T	Nero / Black	Pannello chiuso CSF base H10 / Closed panel CSF base H10

CONFEZIONE N° PCS/KIT: 50	PESO DELLA CONFEZIONE: 1,15 kg	MINIMO ACQUISTABILE: 1	PESO DEL PEZZO KIT: 20 g
PACKAGING N° PCS/KIT: 50	PACKAGING WEIGHT: 1,15 kg	MINIMUM ORDER: 1	KIT WEIGHT: 20 g

PANNELLO CHIUSO H15



Bianco / White



Nero / Black

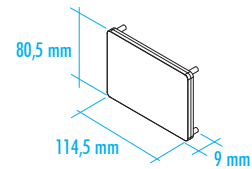

CODICE / CODE	COLORE / COLOUR	DESCRIZIONE/DESCRIPTION
P14005305T	Bianco / White	Pannello chiuso CSF base H15 / Closed panel CSF base H15
P14005105T	Nero / Black	Pannello chiuso CSF base H15 / Closed panel CSF base H15

CONFEZIONE N° PCS/KIT: 50	PESO DELLA CONFEZIONE: 1,25 kg	MINIMO ACQUISTABILE: 1	PESO DEL PEZZO KIT: 22 g
PACKAGING N° PCS/KIT: 50	PACKAGING WEIGHT: 1,25 kg	MINIMUM ORDER: 1	KIT WEIGHT: 22 g

PANNELLO CHIUSO H25



Bianco / White



Nero / Black

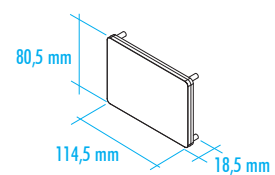

CODICE / CODE	COLORE / COLOUR	DESCRIZIONE/DESCRIPTION
P14002305T	Bianco / White	Pannello chiuso CSF base H25 / Closed panel CSF base H25
P14002105T	Nero / Black	Pannello chiuso CSF base H25 / Closed panel CSF base H25

CONFEZIONE N° PCS/KIT: 50	PESO DELLA CONFEZIONE: 1,40 kg	MINIMO ACQUISTABILE: 1	PESO DEL PEZZO KIT: 25 g
PACKAGING N° PCS/KIT: 50	PACKAGING WEIGHT: 1,40 kg	MINIMUM ORDER: 1	KIT WEIGHT: 25 g



PANNELLO CHIUSO

CARATTERISTICHE GENERALI

Colore: Bianco e nero

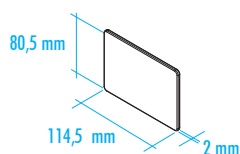

CLOSED PANEL

GENERAL FEATURES

Colour: White and black



CODICE / CODE	COLORE / COLOUR	DESCRIZIONE/DESCRIPTION
P140023749	Bianco / White	Pannello plastico frontale chiuso / Plastic front panel closed
P140033749	Nero / Black	Pannello plastico frontale chiuso / Plastic front panel closed

NOTA: pannello e biadesivo.

NOTE: panel and double-side adhesive.

CONFEZIONE N° PCS/KIT:	25
PACKAGING N° PCS/KIT:	25
PESO DELLA CONFEZIONE:	0,83 kg
PACKAGING WEIGHT:	0,83 kg

MINIMO ACQUISTABILE:	1
MINIMUM ORDER:	1
PESO DEL PEZZO KIT:	27 g
KIT WEIGHT:	27 g

PANNELLO TOUCH RESISTIVO

CARATTERISTICHE GENERALI

Colore: Bianco, nero e neutro

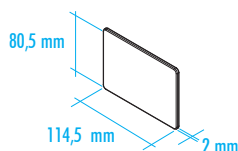

TOUCH RESISTIVE PANEL

GENERAL FEATURES

Colour: White, black and neutral

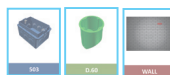

CODICE / CODE	COLORE / COLOUR	DESCRIZIONE/DESCRIPTION
14.TP10000	Nero / Black	Pannello touch resistivo frontale / Front touch resistive panel
14.TP30000	Bianco / White	Pannello touch resistivo frontale / Front touch resistive panel
14.TP00000	Neutro / Neutral	Pannello touch resistivo frontale / Front touch resistive panel

CONFEZIONE N° PCS/KIT:	25
PACKAGING N° PCS/KIT:	25
PESO DELLA CONFEZIONE:	0,65 kg
PACKAGING WEIGHT:	0,65 kg

MINIMO ACQUISTABILE:	1
MINIMUM ORDER:	1
PESO DEL PEZZO KIT:	20 g
KIT WEIGHT:	20 g

PANNELLO IN POLICARBONATO

CARATTERISTICHE GENERALI

Materiale: Policarbonato

Colore: Neutro

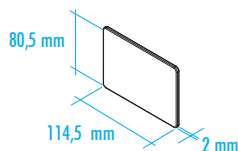

POLYCARBONATE PANEL

GENERAL FEATURES

Material: Policarbonato

Colour: Neutral

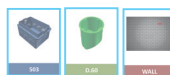

CODICE / CODE	COLORE / COLOUR	DESCRIZIONE/DESCRIPTION
P140013749	Neutro / Neutral	Pannello in polycarbonato trasparente frontale / Polycarbonate front transparent panel *su richiesta /on request

NOTA: pannello e biadesivo.

NOTE: panel and double-side adhesive.

CONFEZIONE N° PCS/KIT:	25
PACKAGING N° PCS/KIT:	25
PESO DELLA CONFEZIONE:	0,70 kg
PACKAGING WEIGHT:	0,70 kg

MINIMO ACQUISTABILE:	1
MINIMUM ORDER:	1
PESO DEL PEZZO KIT:	22 g
KIT WEIGHT:	22 g

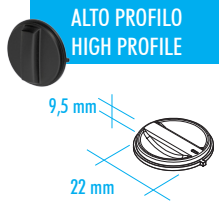
MANOPOLA Ø20**CARATTERISTICHE GENERALI****Materiale:** ABS autoestinguente**Colore:** Bianco e nero**HANDLE Ø20****GENERAL FEATURES****Material:** ABS self-extinguishing**Colour:** White and black

CODICE / CODE	COLORE / COLOUR	DESCRIZIONE/DESCRIPTION
P14003305M	Bianco / White	Manopola Ø 20, alto profilo, con levetta in rilievo / Handle Ø 20, high profile, with lever in relief
P14005305M	Bianco / White	Manopola Ø 20, basso profilo, con nicchia tonda / Handle Ø 20, low profile, with round niche
P14007305M	Bianco / White	Manopola Ø 20, basso profilo, con levetta incassata / Handle Ø 20, low profile, with recessed lever
P14003105M	Nero / Black	Manopola Ø 20, alto profilo, con levetta in rilievo / Handle Ø 20, high profile, with lever in relief
P14005105M	Nero / Black	Manopola Ø 20, basso profilo, con nicchia tonda / Handle Ø 20, low profile, with round niche
P14007105M	Nero / Black	Manopola Ø 20, basso profilo, con levetta incassata / Handle Ø 20, low profile, with recessed lever

CONFEZIONE N° PCS/KIT:	25
PACKAGING N° PCS/KIT:	25
PESO DELLA CONFEZIONE:	0,19 kg
PACKAGING WEIGHT:	0,19 kg

MINIMO ACQUISTABILE:	1
MINIMUM ORDER:	1
PESO DEL PEZZO KIT:	1,5 g
KIT WEIGHT:	1,5 g

MANOPOLA Ø30**CARATTERISTICHE GENERALI****Materiale:** ABS autoestinguente**Colore:** Bianco e nero**HANDLE Ø30****GENERAL FEATURES****Material:** ABS self-extinguishing**Colour:** White and black

CODICE / CODE	COLORE / COLOUR	DESCRIZIONE/DESCRIPTION
P14001305M	Bianco / White	Manopola Ø 30, alto profilo, con levetta in rilievo / Handle Ø 30, high profile, with lever in relief
P14004305M	Bianco / White	Manopola Ø 30, basso profilo, con nicchia tonda / Handle Ø 30, low profile, with round niche
P14006305M	Bianco / White	Manopola Ø 30, basso profilo, con levetta incassata / Handle Ø 30, low profile, with recessed lever
P14001105M	Nero / Black	Manopola Ø 30, alto profilo, con levetta in rilievo / Handle Ø 30, high profile, with lever in relief
P14004105M	Nero / Black	Manopola Ø 30, basso profilo, con nicchia tonda / Handle Ø 30, low profile, with round niche
P14006105M	Nero / Black	Manopola Ø 30, basso profilo, con levetta incassata / Handle Ø 30, low profile, with recessed lever

CONFEZIONE N° PCS/KIT:	25
PACKAGING N° PCS/KIT:	25
PESO DELLA CONFEZIONE:	0,21 kg
PACKAGING WEIGHT:	0,21 kg

MINIMO ACQUISTABILE:	1
MINIMUM ORDER:	1
PESO DEL PEZZO KIT:	2,5 g
KIT WEIGHT:	2,5 g

MANOPOLA / HANDLE

KIT PERNI

CARATTERISTICHE GENERALI

Materiale: ABS autoestinguente
Colore: Bianco



PINS KIT

GENERAL FEATURES

Material: ABS self-extinguishing
Colour: White

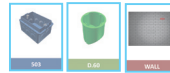

CODICE / CODE	COLORE / COLOUR	DESCRIZIONE/DESCRIPTION
P1400001P	Bianco / White	Kit perni PHIER / Kit PHIER pins

CONFEZIONE N° PCS/KIT:	100	MINIMO ACQUISTABILE: 1	MINIMUM ORDER: 1
PACKAGING N° PCS/KIT:	100		
PESO DELLA CONFEZIONE:	0,35 kg	PESO DEL PEZZO KIT:	2 g
PACKAGING WEIGHT:	0,35 kg	KIT WEIGHT:	2 g

RICAMBI / SPARE PARTS

VITI

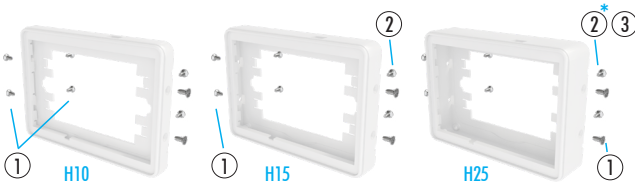

SCREWS

NOTA: prego usare la stessa vite per il telaio o per il pannello integrato.
 NOTE: please use same screw for frame or panel integrated version.



CODICE / CODE	REF	COLORE / COLOUR	DESCRIZIONE/DESCRIPTION
PM10012017	①	Bianco zincata/Galvanized white	Vite d 2,9 x 6,5 TS / Screw d 2,9 x 6,5 TS
PM10012018	②	Bianco zincata/Galvanized white	Vite d 2,9 x 9,5 TS / Screw d 2,9 x 9,5 TS
PM10012019	③	Bianco zincata/Galvanized white	Vite d 2,9 x 19 TS / Screw d 2,9 x 19 TS

*SOLO VERSIONE CSF

*ONLY VERSION CSF

CONF./PACK N° PCS/KIT	MIN. ACQUISTABILE/ MIN. ORDER
① 1000 ② 5000 ③ 1000	① 1 ② 1 ③ 1
PESO DELLA CONF./ PACK. WEIGHT	PESO DEL PEZZO KIT/KIT WEIGHT
① 0,6 kg ② 2,6 kg ③ 1,0 kg	① 0,5 g ② 0,5 g ③ 1 g



STAMPA DIGITALE & LAVORAZIONI MECCANICHE
su pannelli in PLASTICA o VETRO /
DIGITAL PRINTING AND MECHANICAL MACHININGS
IN PLASTIC OR GLASS panels.



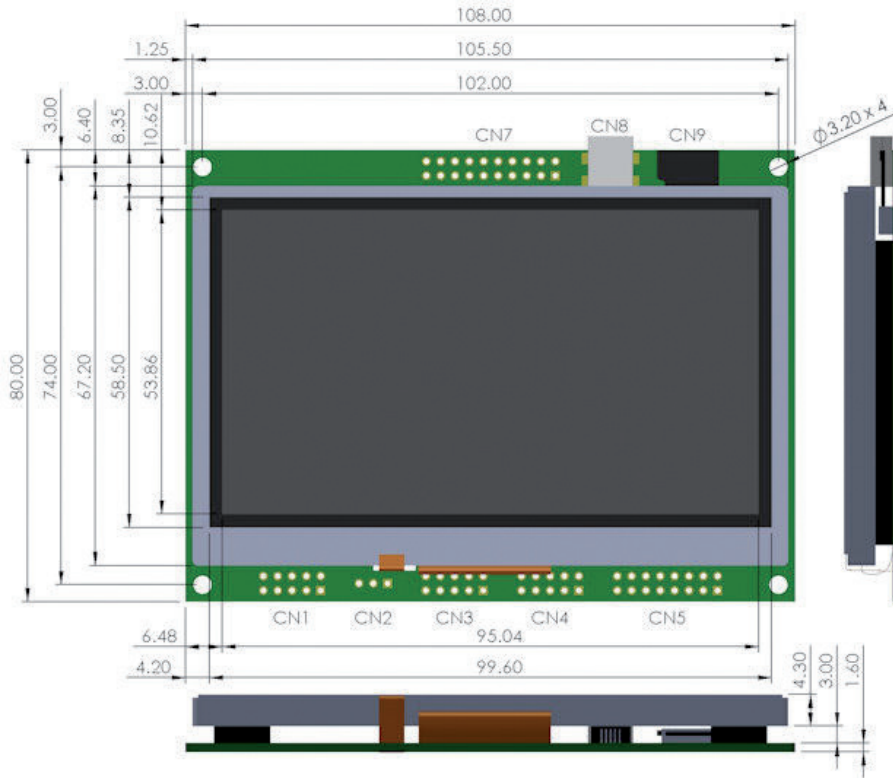

STD Shape

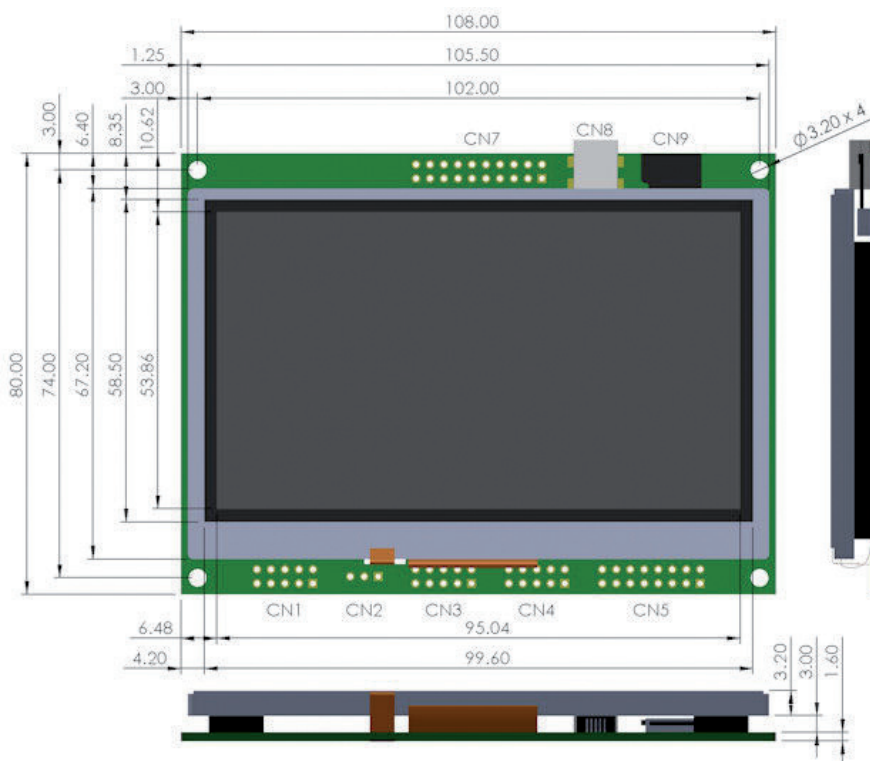

CODICE / CODE	REF	COLORE / COLOUR	DESCRIZIONE / DESCRIPTION
14.TFT4302	①		Display 4.3" con pannello touch integrato con controllo elettronico / Display 4.3" with touch panel integrated and electronic driver
14.TFT4301	②		Display 4.3" senza pannello touch con controllo elettronico / Display 4.3" without touch panel and with electronic driver

NOTA: Il display con la scheda driver embedded è prodotto da Itron UK, per maggiori informazioni vi preghiamo di contattare il costruttore: www.noritake-itron.com

NOTE: Display with embedded board driver is made by Itron UK, for more infos please contact the manufacturer: www.noritake-itron.com

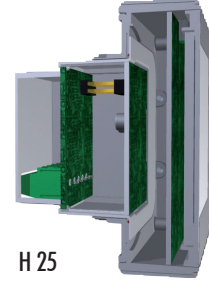
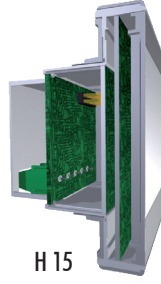
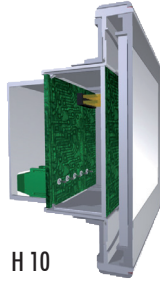

503

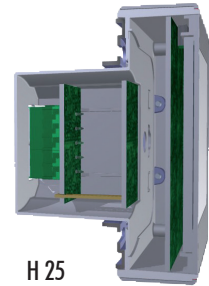
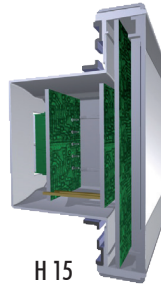
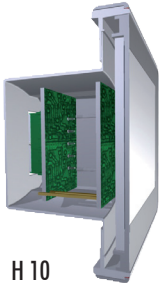

Ø60

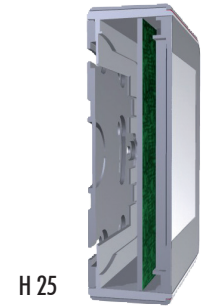
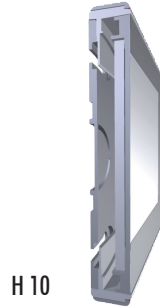
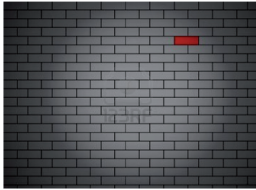

WALL

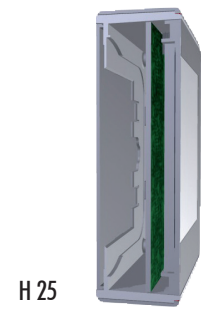

HANDHELD

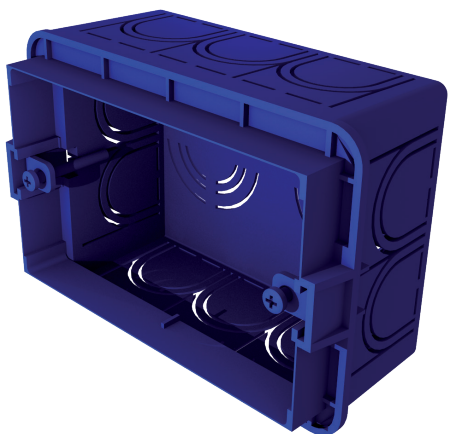

Muro / Wall 503.1

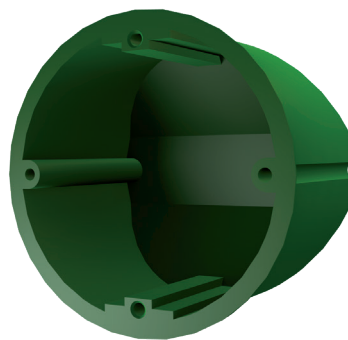

Cartongesso/Plasterboard Ø 60.1



Muro / Wall 503.2

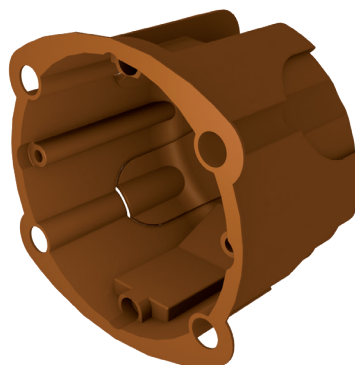

Cartongesso/Plasterboard Ø 60.2

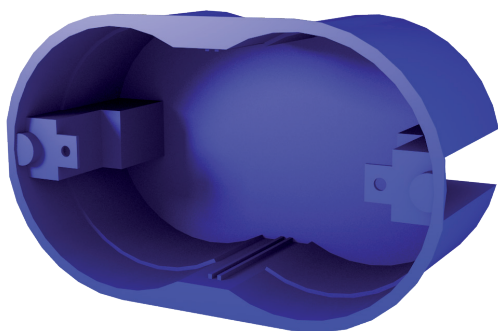

Cartongesso/Plasterboard 503.3

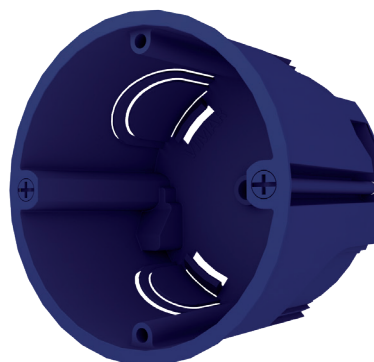

Cartongesso/Plasterboard Ø 60.3

FINISHING SERVICE

ITALTRONIC è da tempo impegnata nella fornitura dei propri contenitori completi di servizi aggiuntivi vari per il completamento dei prodotti esteticamente e meccanicamente. Per fare ciò si è dotato di un ufficio tecnico che può tradurre le note della clientela in disegni esecutivi prima e in campionature per la valutazione finale della corrispondenza al progetto.

Alcuni servizi sono completamente GRATUITI, cioè quando il cliente fornisce dei documenti tecnici già conformi al post process che ITALTRONIC dovrà fare, altri invece sono a pagamento: generalmente quando ITALTRONIC deve sviluppare un progetto sui propri contenitori oppure adattare le informazioni ricevute agli STANDARD necessari per avviare la produzione.

Qui di seguito troverete una semplice traccia di quelle che sono le richieste minime di ITALTRONIC affinché la gestione possa essere veloce, semplice e gratuita, fatto salvo i costi di attrezzatura di base; altrimenti saranno addebitati i costi relativi alle attività svolte dai tecnici ITALTRONIC al puro costo aziendale.

PERSONALIZZAZIONE MECCANICA

Stiamo in grado di fornire un servizio di personalizzazione meccanica del prodotto con l'ausilio di macchine per fresatura CNC, taglio e tranciatura.

Lavorazioni meccaniche su superfici: ABS, PC/ABS, PPO, PC, PMMA, PA

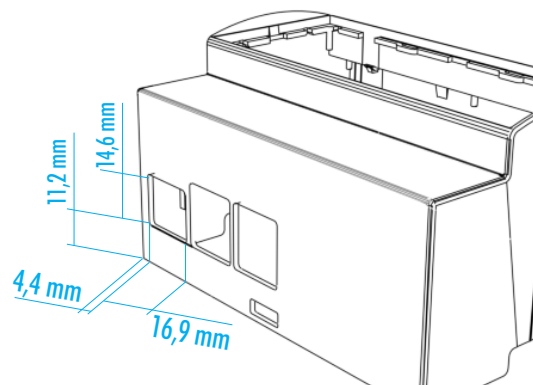

SPECIFICHE TECNICHE RICHIESTE

File: .dwg, .dxf o STEP

Dimensioni: Scala 1:1

In caso contrario, verranno addebitati i costi in base alla complessità nel creare un file di lavorazione. Come modello per la creazione di un file abbiamo bisogno di un disegno/schizzo che contenga tutte le dimensioni di lavorazione pertinenti.

EXTRA COST



OK

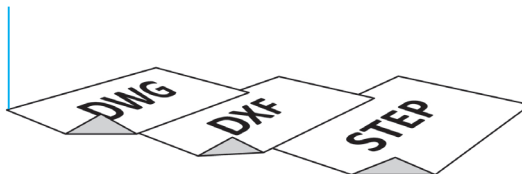

EXTRA COST



SPECIFICHE TECNICHE GARANTITE

Centraggio delle lavorazioni

La centratura di tutte le lavorazioni eseguite da Italtronic è sottoposta a un controllo finale con uno strumento semplice come il calibro.

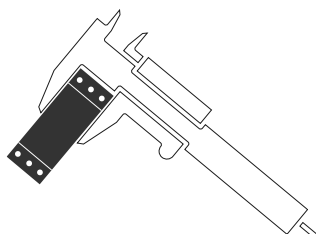

FINISHING SERVICE

For years ITALTRONIC has been working to supply its enclosures with the various additional services to complete the products both externally and mechanically. To do this, we have set up our technical office that is able to translate our customers' notes into initial project drawings and samples to enable a final evaluation of whether they correspond to the project.

Some services are FREE OF CHARGE, i.e. when the customer gives us the technical documents that already conform to the post processing ITALTRONIC has to do, while others are for a fee: usually when ITALTRONIC has to develop a project on its own enclosures, or adapt the information received to the necessary production STANDARDS.

Below you will find a simple guide of the ITALTRONIC minimum requests so that the process can be quick, simple and free, apart from the basic equipment costs, otherwise we will charge you for the work of our ITALTRONIC technicians at the pure cost price.

MECHANICAL PERSONALIZATION

We can supply a product mechanical personalization service with the aid of milling, CNC, cutting and trenching machines.

Mechanical processing: on ABS, PC/ABS, PPO, PC, PMMA, PA surfaces

TECHNICAL SPECS REQUEST

File: .dwg, .dxf o STEP

Dimensions: 1:1 scale

Otherwise, additional costs will be charged, according to the complexity of the print file preparation. As guideline for the final print file, we need to have a drawing / sketch showing all pertinent working dimensions.

GUARANTEED TECHNICAL SPECS

Centring the work

The centring for all the work by Italtronic undergoes a final control using a simple tool, like a gauge.

COME QUOTARE E CONTROLLARE LE MISURE DELLE LAVORAZIONI

Qui sotto riportiamo un esempio di come possono essere eseguite delle misure affinché risultino centrate con altri processi, come quello di STAMPA, e siano ortogonali ai piani di riferimento dei nostri prodotti.

HOW TO QUOTE AND TO CHECK THE MACHINING DIMENSIONS

Below is an example of how the measurements can be taken so that they are centred with other processes, such as PRINT, and are at right angles to the reference surfaces of our products.

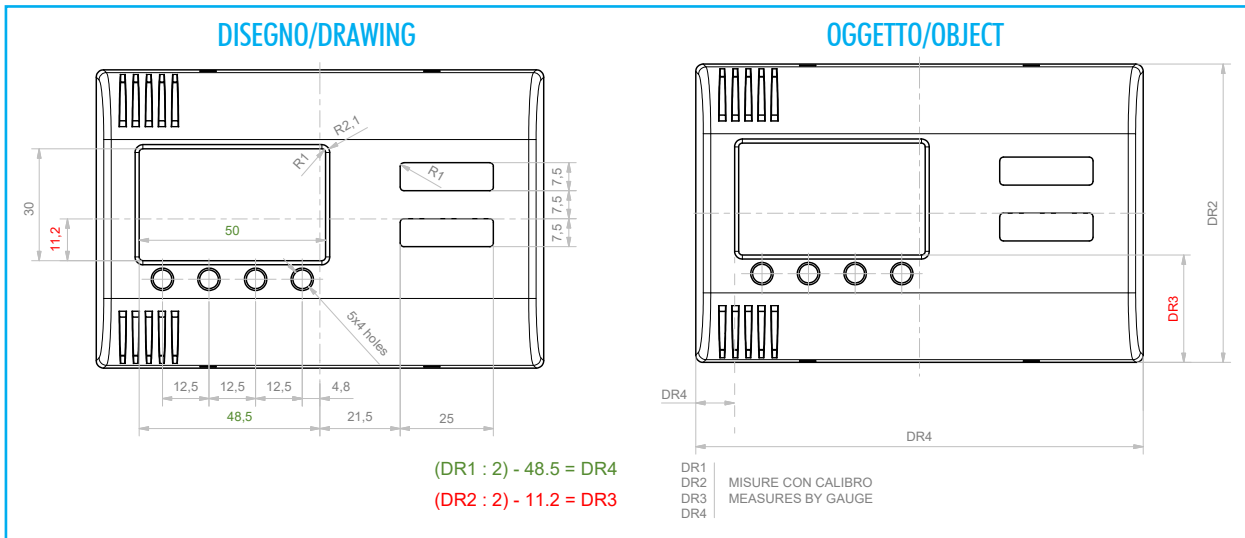

SVASATURE E RIBASSI

ITALTRONIC offre un ottimo servizio di finitura meccanica adatta a migliorare l'estetica del prodotto, con svasature e ribassi.

FLARING & LOWERING

ITALTRONIC offers a very good mechanical Finishing Service for a better aesthetics result of the products, with flaring and lowering.

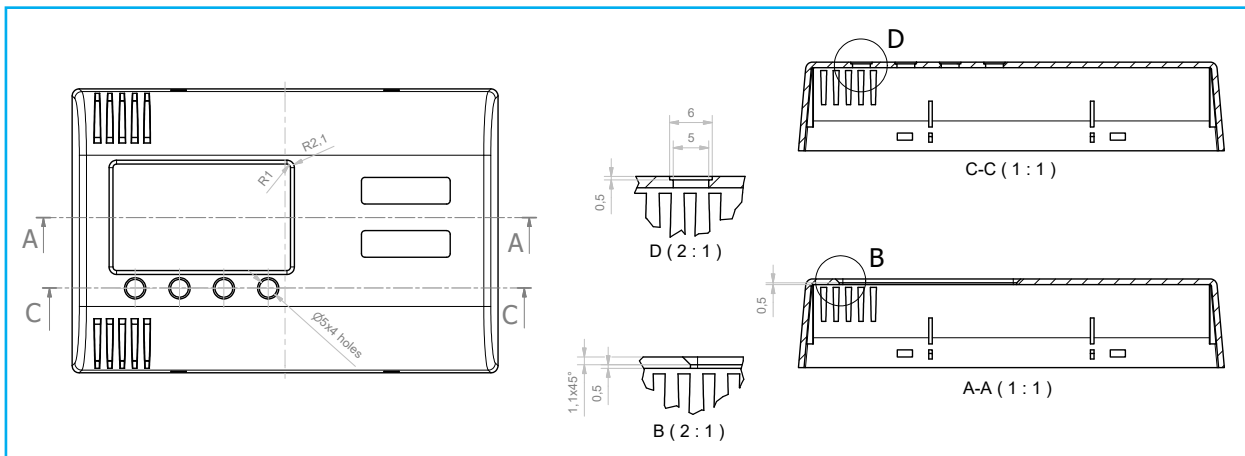

Le tolleranze dimensionali possono essere ristrette se indicate nel disegno del cliente e se compatibili con i nostri processi produttivi: la fornitura del nostro disegno controfirmata fa da garanzia.

The size tolerances can be less if they are indicated in the customer's drawing and are compatible with our production processes: the supply of our countersigned drawing guarantees this.

Tolleranze dimensionali/Tolerance limits

Secondo tolleranze generali UNI EN 22768/1 media (m):

Average tolerances as per UNI EN 22768/1 medium (m):

DA 0.5 A 3 mm/FROM 0.5 TO 3mm	±0.1 mm
DA 3 FINO A 6 mm/FROM 3 TO 6mm	±0.1 mm
OLTRE 6 FINO A 30 mm/BEYOND 6 AND UP TO 30 mm	±0.2 mm
OLTRE 30 FINO A 120 mm/BEYOND 30 AND UP TO 120 mm	±0.3 mm
OLTRE 120 FINO A 400 mm/BEYOND 120 AND UP TO 400 mm	±0.5 mm

PERSONALIZZAZIONE GRAFICA

ITALTRONIC fornisce un ottimo servizio di personalizzazione grafica sui propri prodotti. È opportuno prendere visione delle note più sotto per ottenere risposte veramente veloci e costi ridotti al minimo.

Nota: Tutti i contenuti devono essere modificabili (generalmente i file non vettoriali non sono modificabili)

In caso contrario, verranno addebitati i costi in base alla complessità nel creare un file di stampa. Per la creazione di un file di stampa a partire da zero abbiamo bisogno di un disegno / schizzo che contenga tutte le dimensioni di lavorazione pertinenti. Se non è possibile fornire i loghi, i simboli (come file di immagine, ad es. Jpg con risoluzione min. 1200 dpi) o eventuali caratteri speciali, sono possibili lievi non conformità.

DOCUMENTAZIONE TECNICA RICHIESTA DA ITALTRONIC

File di stampa ottimale: layout deve sempre essere una grafica vettoriale (no grafica raster) in formato Adobe Illustrator, EPS, file .pdf vettoriale o Corel Draw.

GRAPHIC PERSONALIZATION

ITALTRONIC provides an excellent customised graphic service on its products. Read the notes below for a quick answer and costs reduced to the minimum.

Note: All contents must be editable (non-vector files usually cannot be modified)

Otherwise, additional costs will be charged, according to the complexity of the print file preparation. In order to create a print file from scratch, we need to have a drawing / sketch showing all pertinent working dimensions. If it is not possible to supply logos, symbols (in image-format files, such as jpg, with a minimum resolution of 1200 dpi) as well as any special non-standard characters, slight differences should be expected.

TECHNICAL DOCUMENTATION REQUIRED BY ITALTRONIC

Optimal print file: the layout must always be a vector graphic (no raster graphic) in Adobe Illustration EPS format, vector PDF or Corel Draw.

EXTRA COST



OK

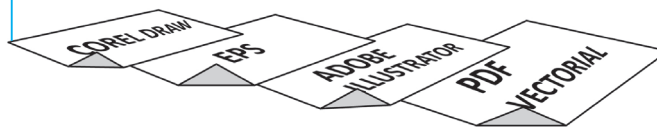

EXTRA COST



Nel caso in cui parte del file (o tutto il file non sia vettoriale, potremo accettare file con le caratteristiche: scala 1:1, inclusi file di immagine, ad esempio jpg o bmp risoluzione minima 1200 dpi.

In case part of the file (or the entire file) is not a vector graphic, we may consider files having the following characteristics: scale 1:1, including image files such as jpg or bmp, 1200 dpi minimal resolution.



Nota: Esempio file immagine alta risoluzione (1200 dpi)
Note: High resolution image file example (1200 dpi)

Nota: Esempio file immagine bassa risoluzione (<1200 dpi)
Note: Low resolution image file example (<1200 dpi)

SPECIFICHE TECNICHE GARANTITE

CENTRAGGIO DELLE STAMPE

La centratura di tutte le lavorazioni eseguite da ITALTRONIC è sottoposta a un controllo finale con uno strumento semplice come il calibro.

Qui sotto riportiamo un esempio di come possono essere eseguite delle misure affinché risultino centrate con altri processi, come quello di CNC, e siano ortogonali ai piani di riferimento dei nostri prodotti.

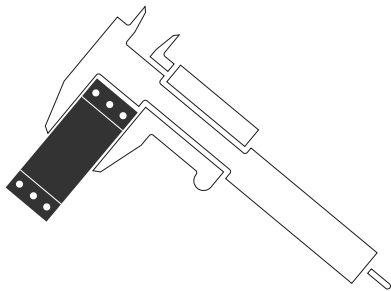

Le tolleranze possono essere ristrette se indicate nel disegno del cliente e se compatibili con i nostri processi produttivi: la fornitura del nostro disegno controfirmato fa da garanzia.

GUARANTED TECHNICAL SPECS

PRINTING CENTRING

The centring for all the work by Italtronic undergoes a final control using a simple tool, like a gauge.

Below is an example of how the measurements can be taken so that they are centred with other processes, such as CNC, and are at right angles to the reference surfaces of our products.

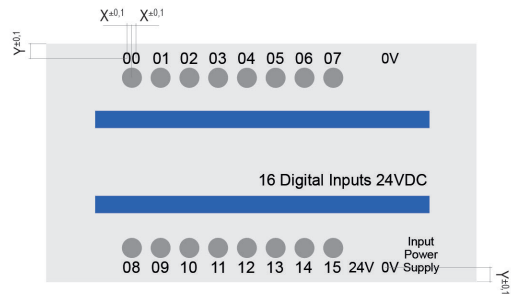

The size tolerances can be less if they are indicated in the customer's drawing and are compatible with our production processes: the supply of our countersigned drawing guarantees this.

Tolleranze dimensionali/Tolerance limits

Con stampa di forma (mm) secondo tolleranze generali UNI EN 22768/1 media (m):

With dye (mm) printing having average tolerances as per UNI EN 22768/1 medium (m):

DA 0.5 A 3 mm/FROM 0.5 TO 3 mm	±0.1 mm
DA 3 FINO A 6 mm/FROM 3 TO 6 mm	±0.1 mm
OLTRE 6 FINO A 30 mm/BEYOND 6 AND UP TO 30 MM	±0.2 mm
OLTRE 30 FINO A 120 mm/BEYOND 30 AND UP TO 120 mm	±0.3 mm
OLTRE 120 FINO A 400 mm/BEYOND 120 AND UP TO 400 mm	±0.5 mm
VARIAZIONI PERMESSE/PERMITTED VARIATIONS	Ampiezza della linea ± 10%/Line extent ± 10%
TOLLERANZA DI SPAZI VUOTI/EMPTY SPACE TOLERANCE	Contorno esterno e ritagli (mm) ± 0.3*/External contour and cropping (mm) ± 0.3*

STAMPA DIGITALE

La stampa digitale è particolarmente indicata quando sono richiesti molti colori, sfumature e tempi rapidi di esecuzione con costi contenuti; per quantità da basse a medio alte.

Il processo di stampa digitale UV con qualità fotografica permette facilmente di poter avere la massima flessibilità per realizzare qualsiasi tipo di grafica a più colori ad un prezzo competitivo anche per piccoli lotti.

Si tratta di una stampa in quadricromia a getto d'inchiostro successivamente catalizzato a mezzo UV, con una dimensione dei pixel molto ridotta che però non consente di ottenere esattamente la tonalità di colore richiesta (scala RAL o PANTONE).

SPECIFICHE TECNICHE:

Superfici: Stampa su ABS, PC/ABS, PPO, PC, PMMA, PA

Profondità massima: 1,5 mm

Colori: CMYK + bianco

Risoluzione: fino a 1440x1200 dpi

Formato massimo di stampa: 297x420 mm



STAMPA TAMPOGRAFICA

La stampa tampografica è consigliata quando è sufficiente un solo colore e la profondità (scalino) di stampa è superiore a 1,5 mm.

È un procedimento di stampa indiretto, che permette di riprodurre, in modo semplice con elevata fedeltà e risoluzione disegni, scritte e decori sia su superfici piane che su superfici concave, convesse o comunque irregolari. Consigliamo l'impiego di questa tecnologia fino ad un massimo di 2 colori (esempio pannello a 1 o 2 colori) su nostri coprimorsetti, contenitori e anche pannelli.

SPECIFICHE TECNICHE:

Superfici: Stampa su ABS, PC/ABS, PPO, PC, PMMA, PA

Colori: Tutti

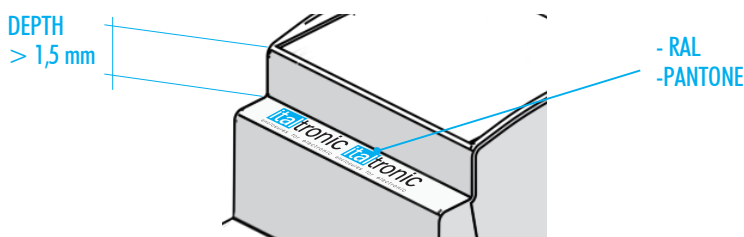

STAMPA SERIGRAFICA

È una tecnologia consolidata di stampa industriale, molto utilizzata in tutte le applicazioni in cui sia richiesto un deposito di inchiostro più elevato rispetto ad altre tecnologie di stampa su superfici piane. Il principio per cui una racle spingendo un inchiostro o una pasta attraverso una maglia aperta di un tessuto tecnico ne ottiene un passaggio uniforme e controllato.

SPECIFICHE TECNICHE:

Superfici: Stampa su ABS, PC/ABS, PPO, PC, PMMA, PA

Colori: Tutti

MARCATURA LASER

Consente l'identificazione permanente (monocromatica) del prodotto anche con tratti molto sottili.

SPECIFICHE TECNICHE:

Superfici: Stampa su ABS, PC/ABS, PPO

Colori: Colore a contrasto a seconda del tipo di materiale

DIGITAL PRINT

Digital printing is ideal when a lot of colours are involved, with shading and fast production with limited costs; for small, medium and large quantities.

The UV digital print process with photographic quality allows maximum flexibility in the realization of any type of graphic in several colours and at a very competitive price, even for small quantities.

It is an inkjet four-colour printing method subsequently catalysed by UV, with a consistently reduced pixel size which, on the other hand, does not guarantee exact colour tonality reproduction (RAL table or pantone).

TECHNICAL SPECS:

Surfaces: Print on ABS, PC/ABS, PPO, PC, PMMA, PA

Maximum depth: 1,5 mm

Colours: CMYK + white

Resolution: up to 1440x1200 dpi

Maximum print size: 297x420 mm

PAD PRINTING

Pad printing is recommended when just one colour is sufficient and the printing depth (step) is more than 1.5 mm.

It is an indirect printing process, which allows reproducing high-fidelity and high resolution drawings, writings and decors, on either flat, concave, convex or anyway irregular surfaces. We suggest this technology for prints up to 2 colour (e.g. a panel in 1 or 2 colours) on our terminal covers, containers and panels, too.

TECHNICAL SPECS:

Surfaces: Print on ABS, PC/ABS, PPO, PC, PMMA, PA

Colours: All

SERIGRAPHY PRINTING

It is a consolidated industrial print system, very much used in all applications requiring thicker ink layers in comparison with other flat-surface print technologies. The principle consists in a blade pushing the ink or paste through hollow tangles of technical fabrics, obtaining a controlled and uniform result.

TECHNICAL SPECS:

Surfaces: Print on ABS, PC/ABS, PPO, PC, PMMA, PA

Colours: all

LASER ENGRAVING

Allows permanent identification (monochrome) of the product, even with very thin strokes.

TECHNICAL SPECS:

Surfaces: Print on ABS, PC/ABS, PPO

Colours: Contrasting colour depending on the material type

Riproducibilità del colore/Colour reproducibility

	SERIGRAFIA/SERIGRAPHY	TAMPOGRAFIA/PAD-PRINTING	DIGITALE/ DIGITAL
FEDELTA'/ FIDELITY	90%	90%	100%
COLORE CAMPIONE/SAMPLE COLOUR	100%	100%	60%



Italtronic Srl

Corso Stati Uniti 17
35127 Padova - Italy
T. +39 049 8947150
F. +39 049 8947151
www.italtronic.com

